

Direct detection of CRs

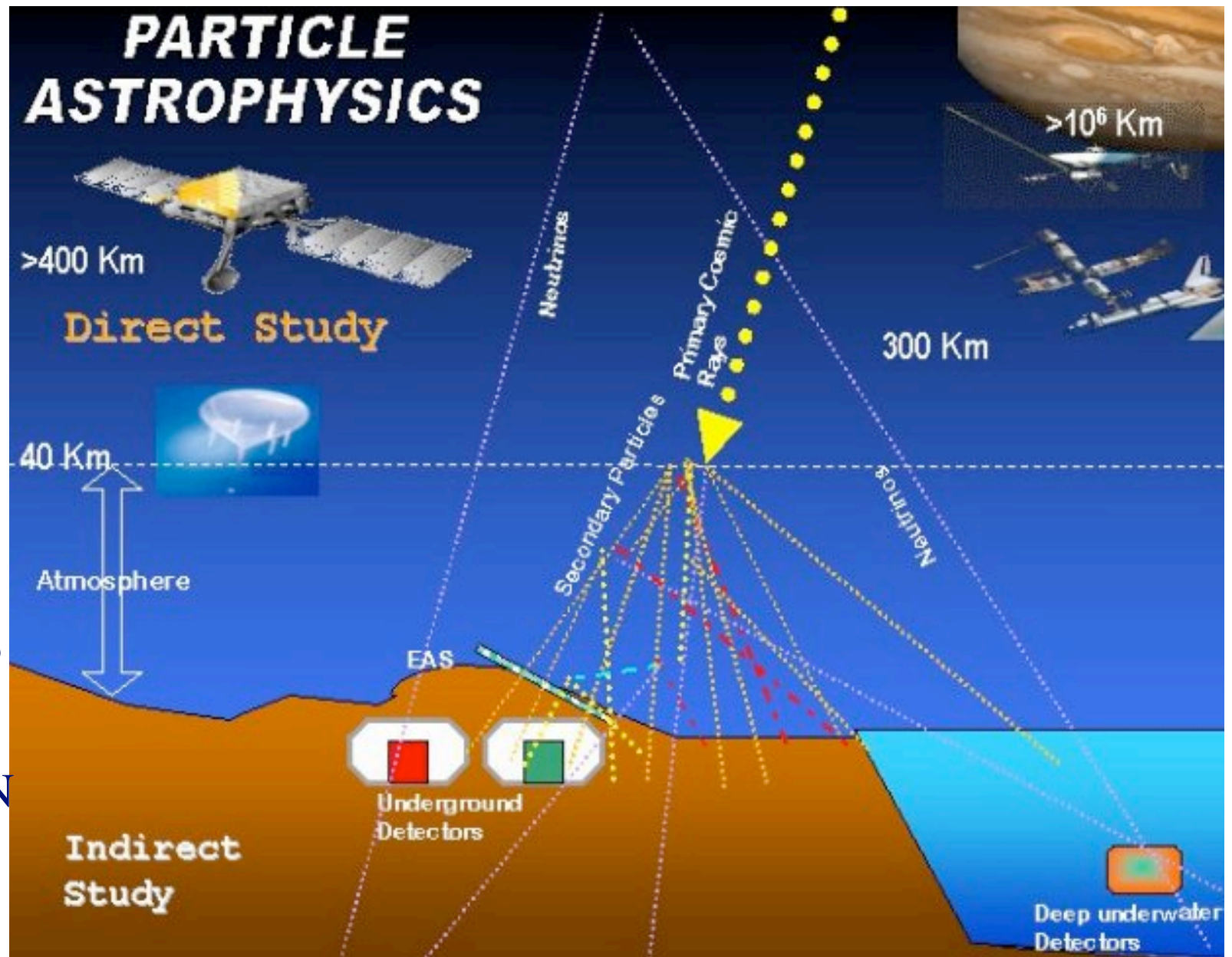

BESS



Thanks
to
Francesco
Cafagna
Bari INFN

A typical CR experiment for PID

Particle id: charge, mass, energy/momentum,

Spectrometer: gyroradius of a particle is proportional to the rigidity and inversely proportional to the magnetic field

Since B is known, Z and p can be measured

$$r_L = \left(\frac{pc}{Ze} \right) \frac{1}{Bc} \quad R = \frac{pc}{Ze}$$

The momentum resolution is limited by the position measurement and by the multiple scattering in the magnet

A **ToF system** (e.g. A,C 2 scintillator counters or proportional counters or spark chambers) provide dE/dx, time, position and trigger.

Hence the time of flight of a particle over a known distance gives the velocity

Hence the particle is fully identified (Z and m)

Occasionally a destructive detector (**calorimeter**) can be used to have an independent energy measurement

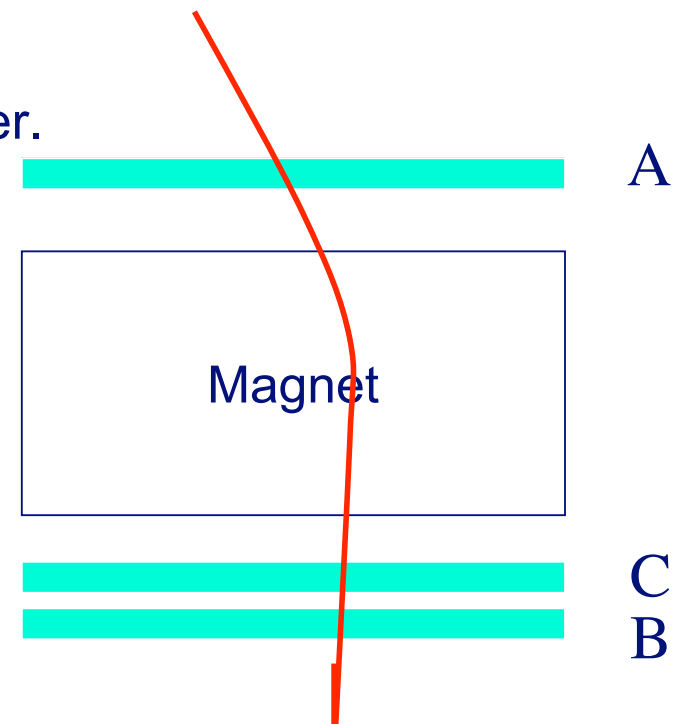

Searches for anti-matter and primary CR composition

- PAMELA
- AMS
- BESS
- Caprice
- Tiger, Atic, HEAT, Jacee, Runjob, ...

Anti-matter in CRs

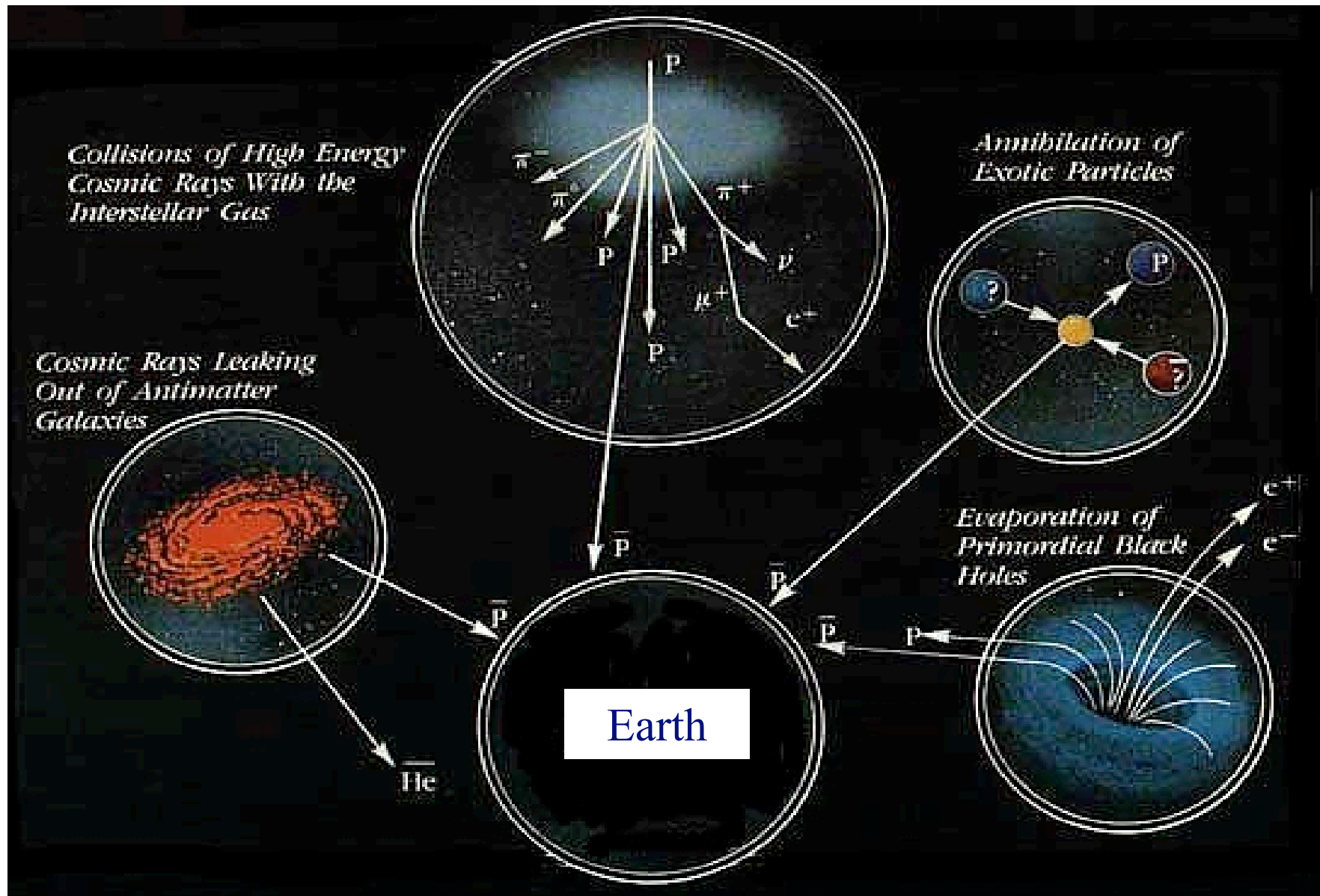

Absolute fluxes

- No clear evidence
 - But errors are large
 - Ratios are better known
 - Flattening at low energy
- anti-matter from BH evaporation
Decay of anti-matter at higher energies

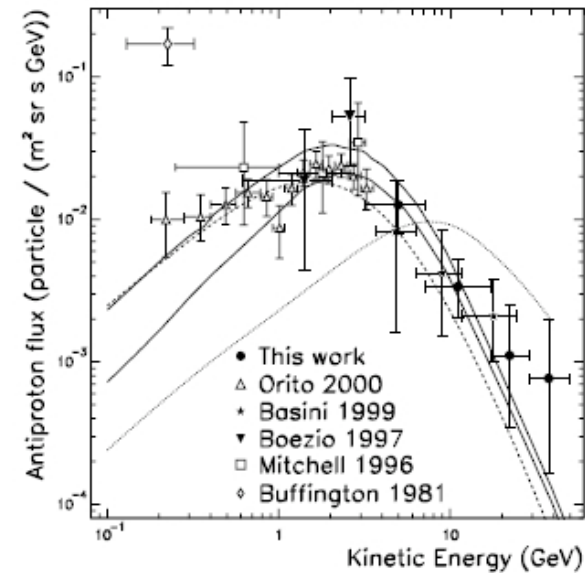
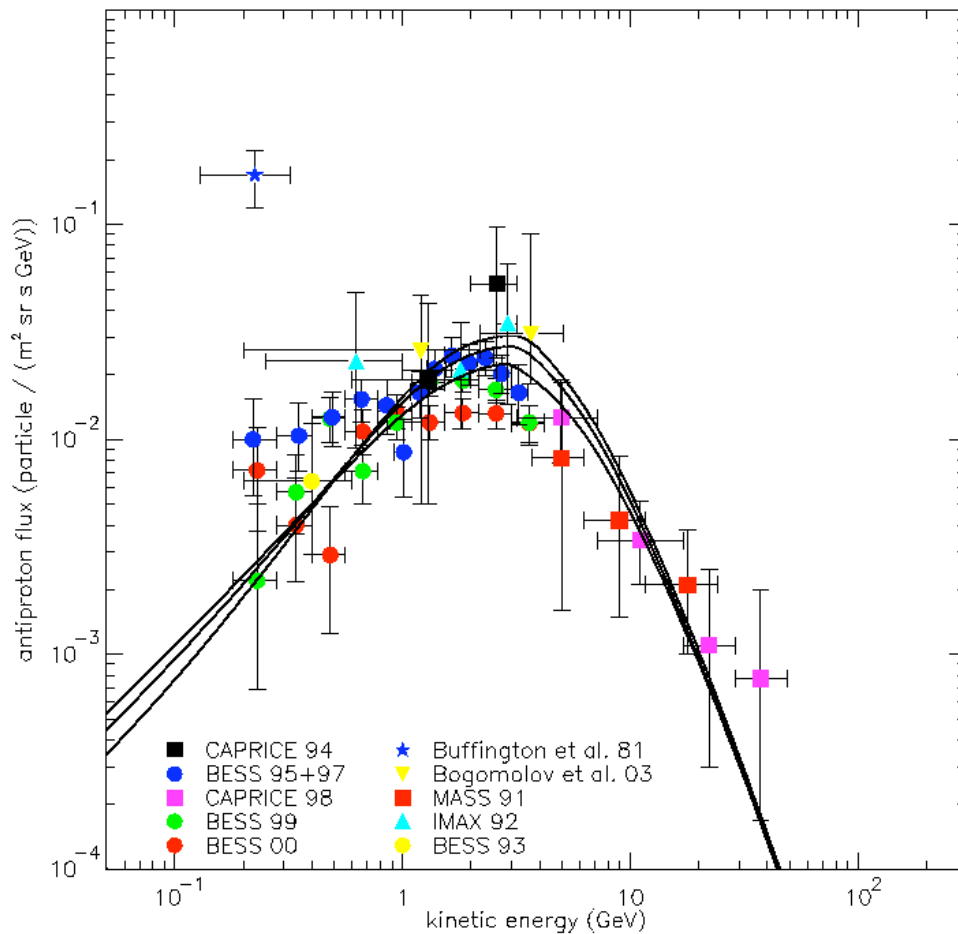

Ratios

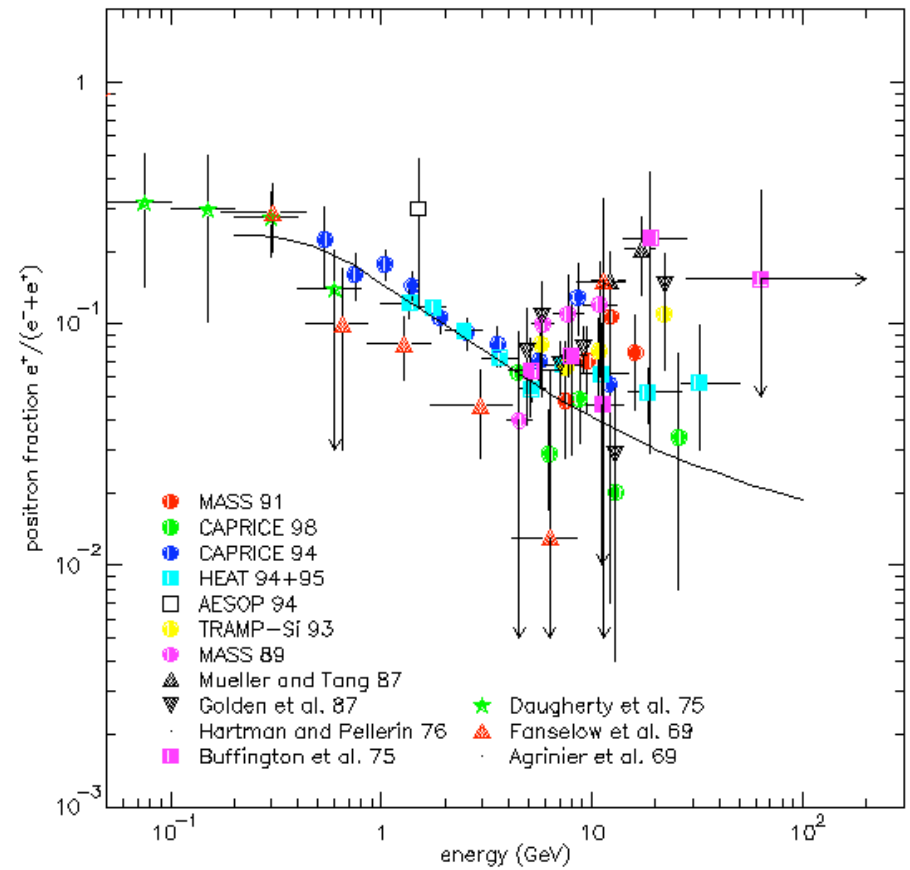
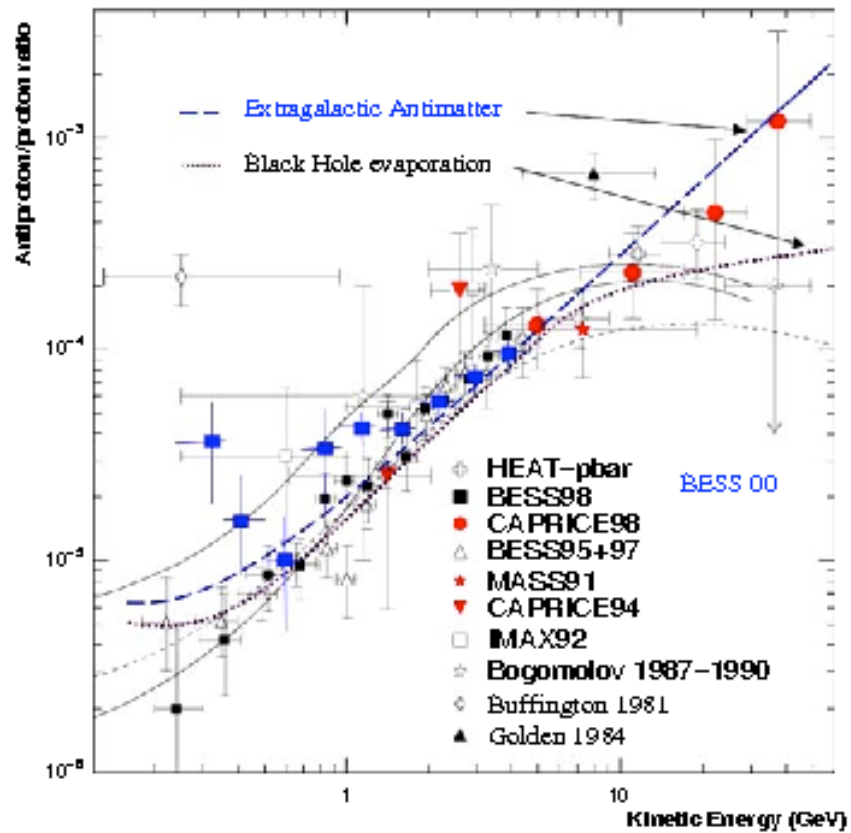

The Antimatter hunter toolkit

- **Spectrometer:**
 - We need to discriminate the particle charge
 - GOOD Maximum Detectable Rigidity (MDR): we need to push the measured rigidity range up to high energies
 - Magnet (permanent, superconducting at cryogenic T with currents) + Tracker (Gas detectors, solid state detectors)
- **Particle discrimination:**
 - We need to tag very few events out of a large background: positrons out of protons, antiprotons out of electrons
 - Typically we have to catch one antiparticle out of 10^{5-6} particles

MDR of a Spectrometer

- What is the MDR ?
 - The rigidity for which the error $\Delta p/p = 100\%$
- Why an MDR of 800 GV could mean a maximum momentum of 190 GeV/c ?
 - **Spillover** ! At high energy particle charge is confused due to the finite spectrometer precision
 - Fake antiprotons due to protons “spilling” into the antiprotons spectra

Spectrometer

- We measure deflection: $\eta = 1/R \propto 1/p$
- If p is high, small deflection, difficult charge determination \Rightarrow spillover
- For this quantity error is gaussian
- Spillover is calculated convolving spectra with spectrometer resolution

$$R = \frac{pc}{Ze}$$

$$r_L = \left(\frac{pc}{Ze} \right) \frac{1}{Bc}$$

If gaussian error added, finite resolution changes 'ideal' spectra

Exercise 9

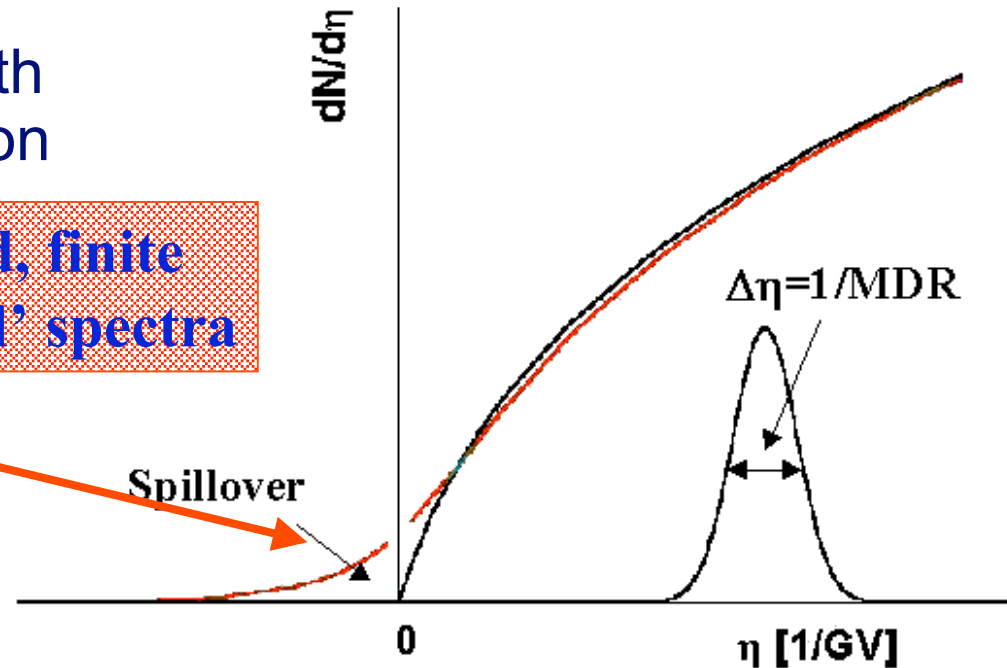

Particle discrimination

- Depends on the energy range we are interested in:
 - Low energy: TOF, Cherenkov, Pre Showers
 - High energy: RICH, TRD, electromagnetic calorimeters

PAMELA

- The observational objectives of the PAMELA instrument are to:
 - measure the spectra of antiprotons, positrons and nuclei in a wide range of energies,
 - to search for primordial antimatter,
 - to study the cosmic ray fluxes over half a solar cycle.
- PAMELA will be able to measure magnetic rigidities (momentum/charge) up to its Maximum Detectable Rigidity (MDR) of 700 GV/c).

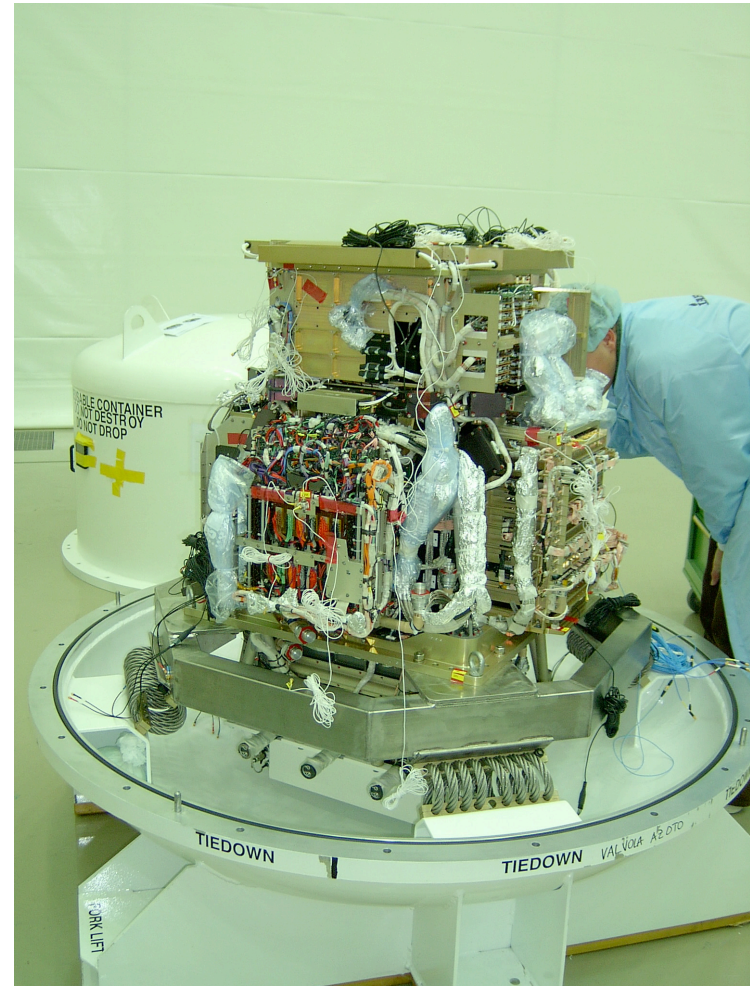

PAMELA

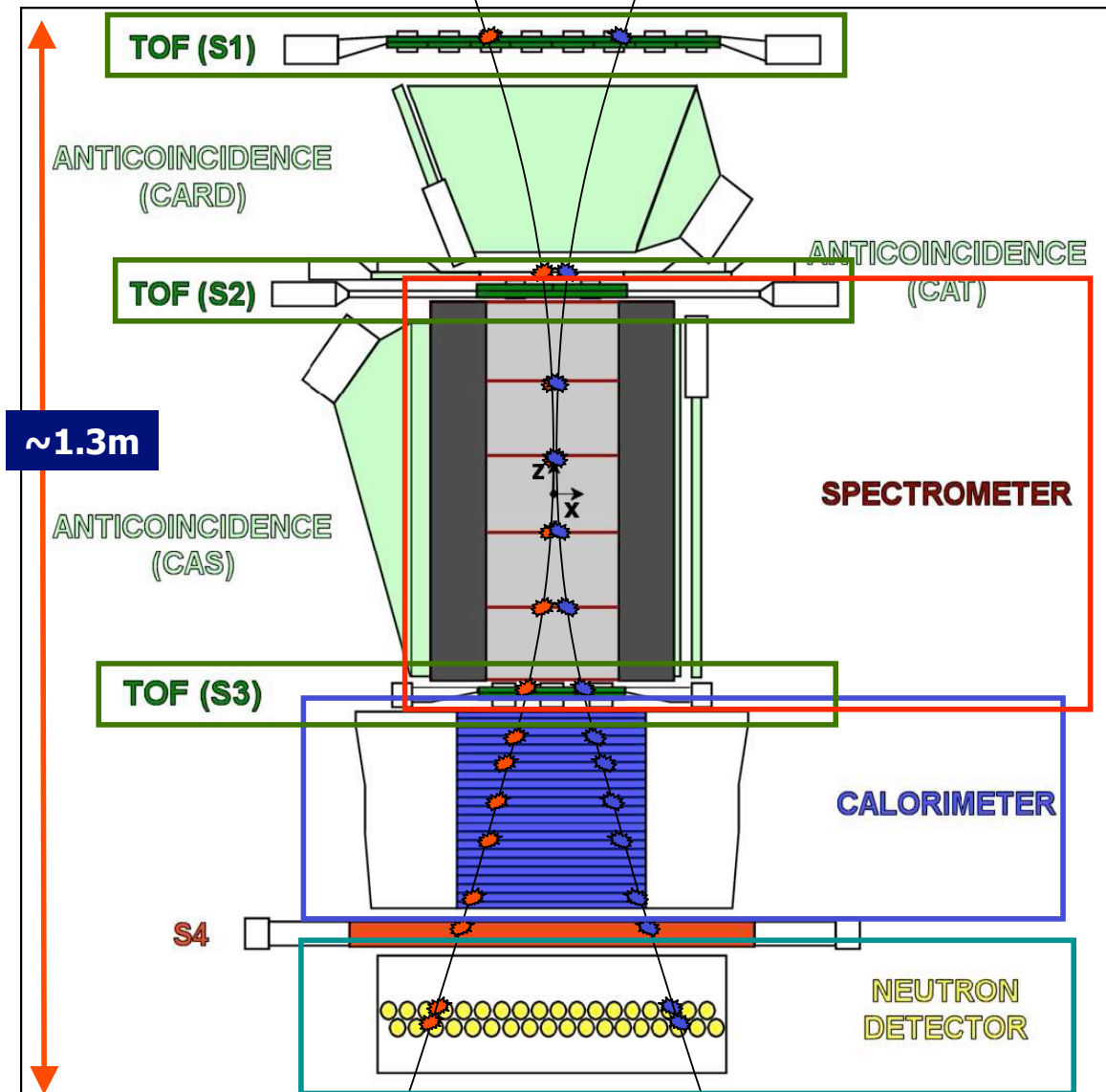

- Particle ID using:
 - TOF
 - Em. Calorimeter
 - Neutron detector
 ^3He n capture to help em/h shower id
- Rigidity determination using spectrometer permanent magnet and silicon tracker

PAMELA: the integration

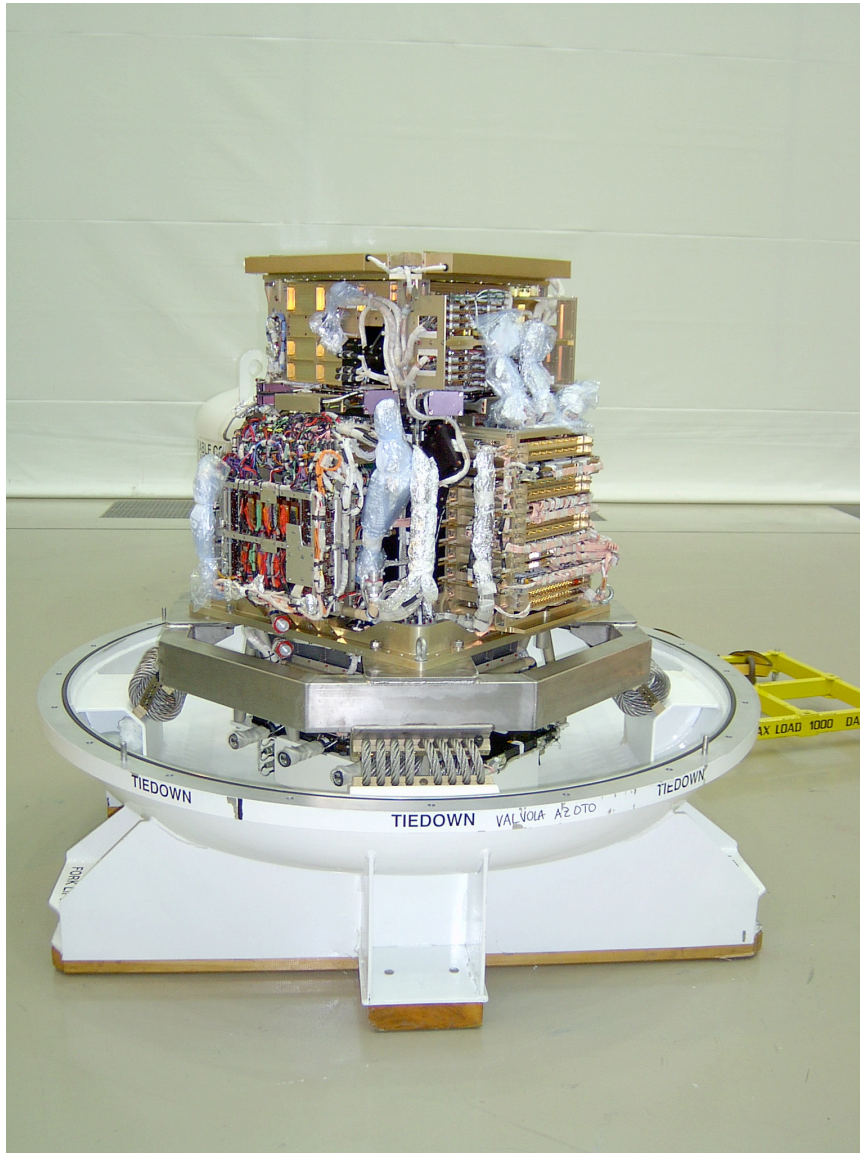

PAMELA

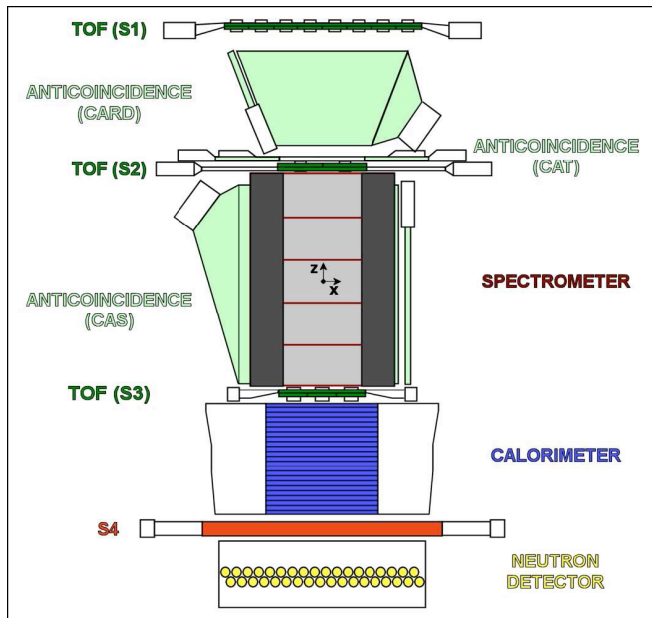

Particle	Number (3 yrs)	Energy Range
Protons	$3 \cdot 10^8$	80 MeV - 700 GeV
Antiprotons	$>3 \cdot 10^4$	80 MeV - 190 GeV
Electrons	$6 \cdot 10^6$	50 MeV - 2 TeV
Positrons	$>3 \cdot 10^5$	50 MeV - 270 GeV
He	$4 \cdot 10^7$	80 MeV/n - 300 GeV/n
Be	$4 \cdot 10^4$	80 MeV/n - 300 GeV/n
C	$4 \cdot 10^5$	80 MeV/n - 300 GeV/n
Antihelium Limit (90% C.L.)	$7 \cdot 10^{-8}$	80 MeV/n - 30 GeV/n

Resurs DK satellite

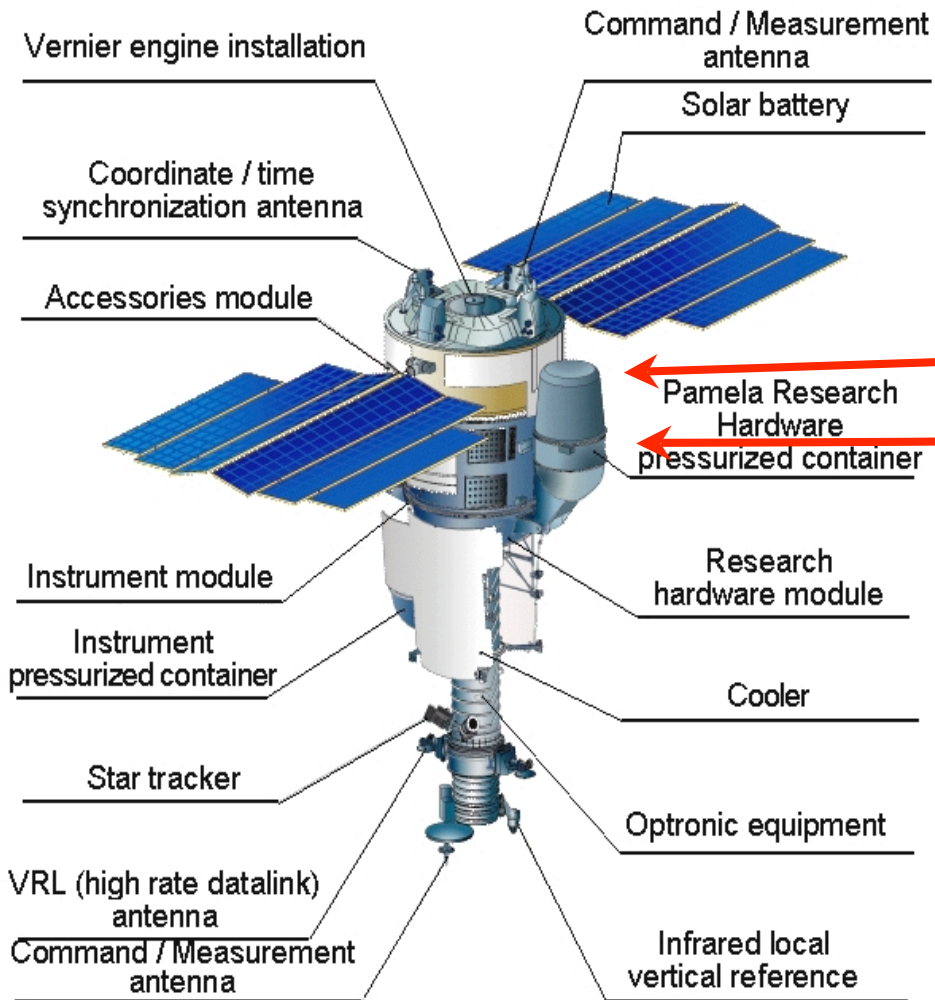

- Satellite Mass: ~10 tons
- Pamela Container Total Mass: ~750 kg
- PAMELA Mass: 470 kg
- PAMELA Power: 380 W
- Orbit :
 - Elliptic (300 ÷ 600 km)
 - Inclination: 70.4°

PAMELA in the satellite

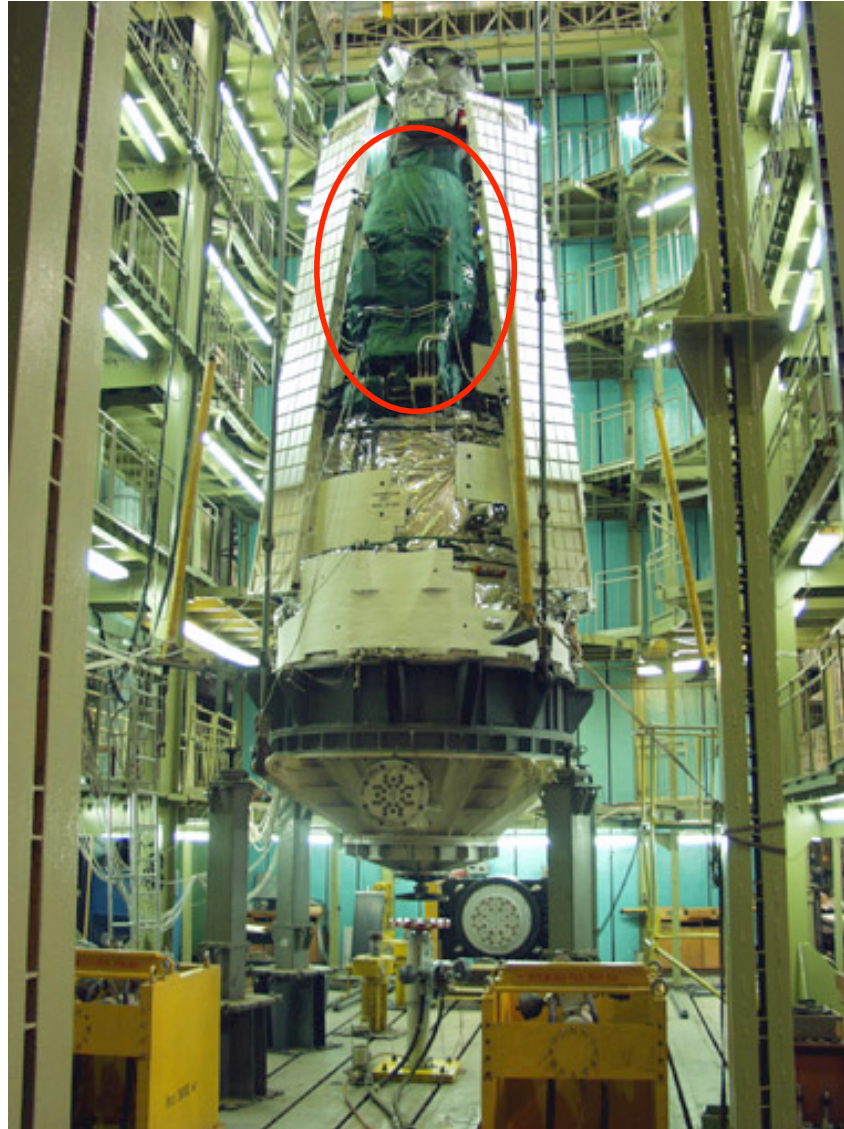

Magnetic Spectrometer

- Permanent magnet
 - 5 blocks of Nd-B-Fe
 - 0.48 T
cavity
 - Magnetic tower =
13.2 x 16.2 cm²
44.5 cm

20.5 cm² sr

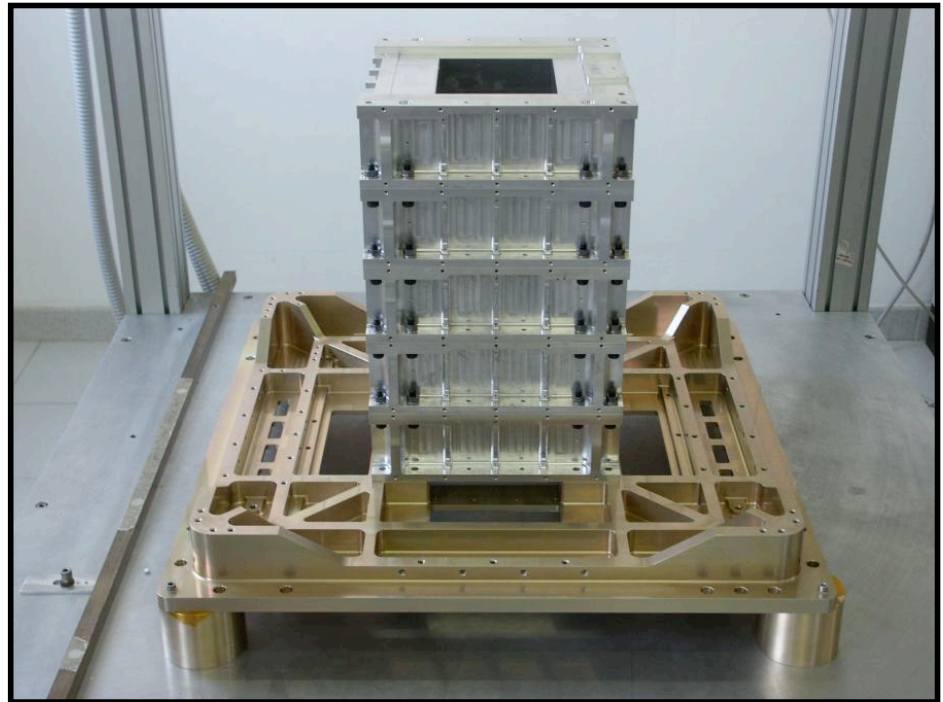

Magnet Construction

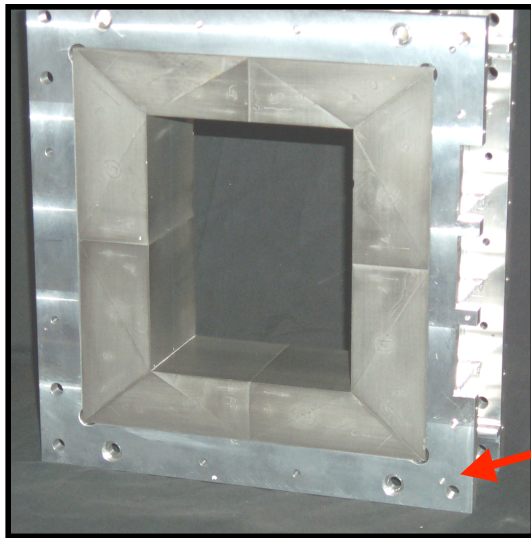
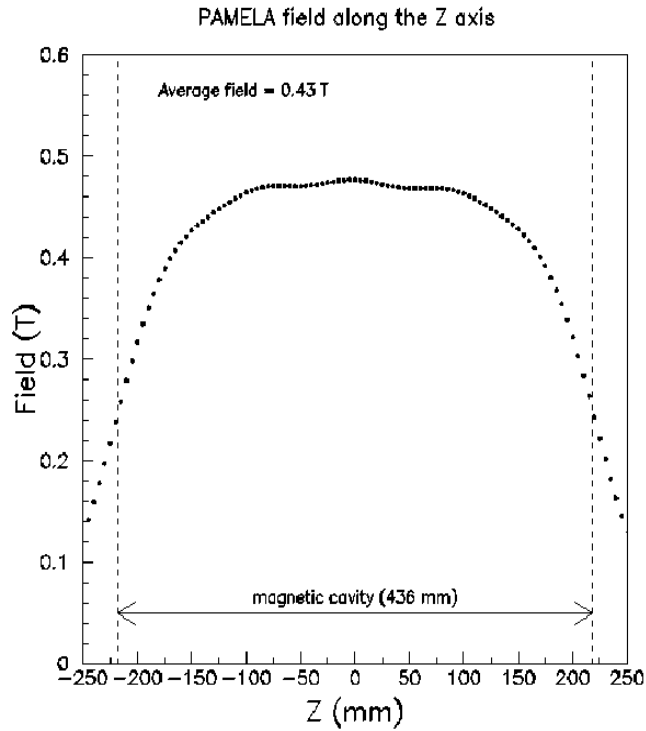
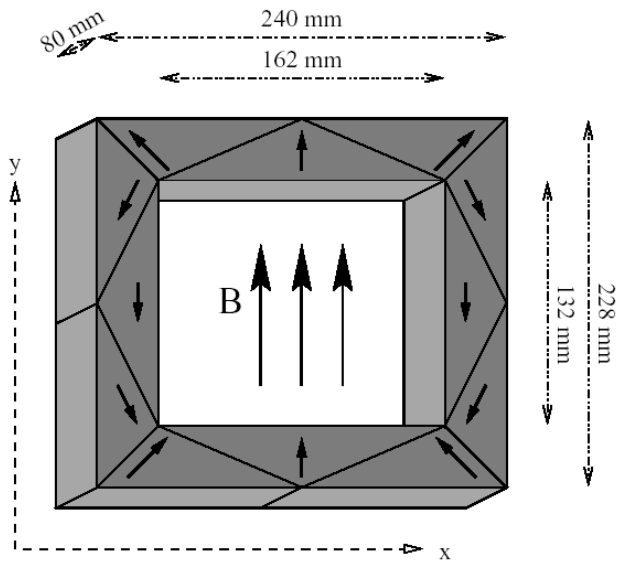

Support canister

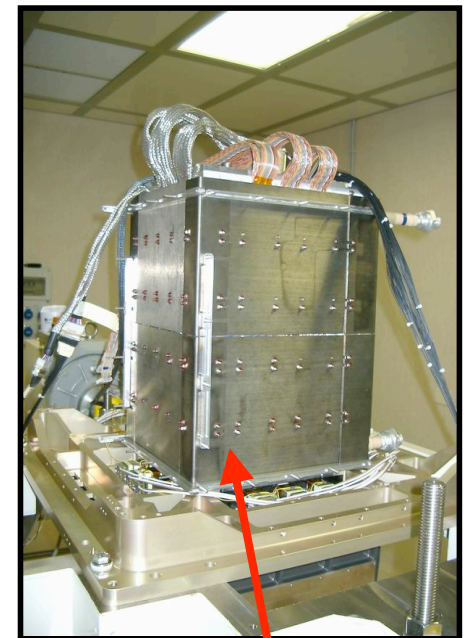

Ferromagnetic shields

Silicon Planes

- **Double-sided silicon microstrips** (300 μm thick):
 - 25 μm implantation pitch (junction side) / 67 μm (ohmic side)
 - Strips mutually orthogonal on opposite sides
 - Readout pitch 50 μm

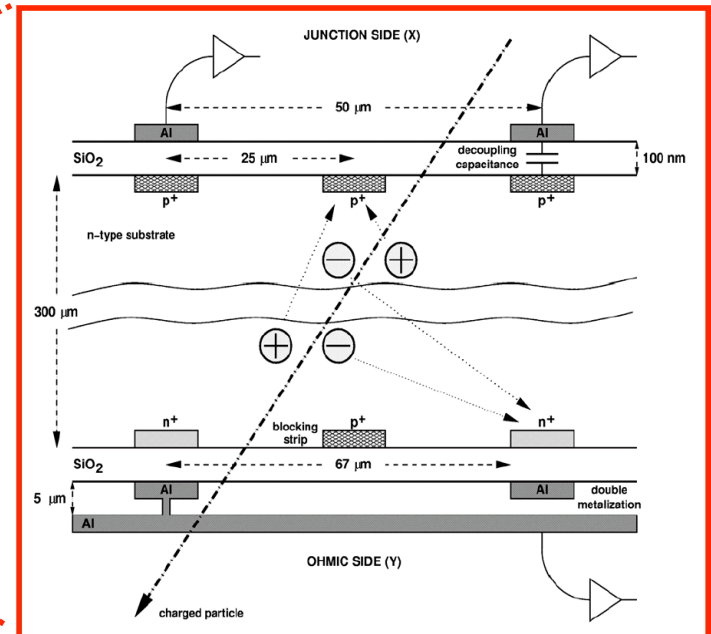
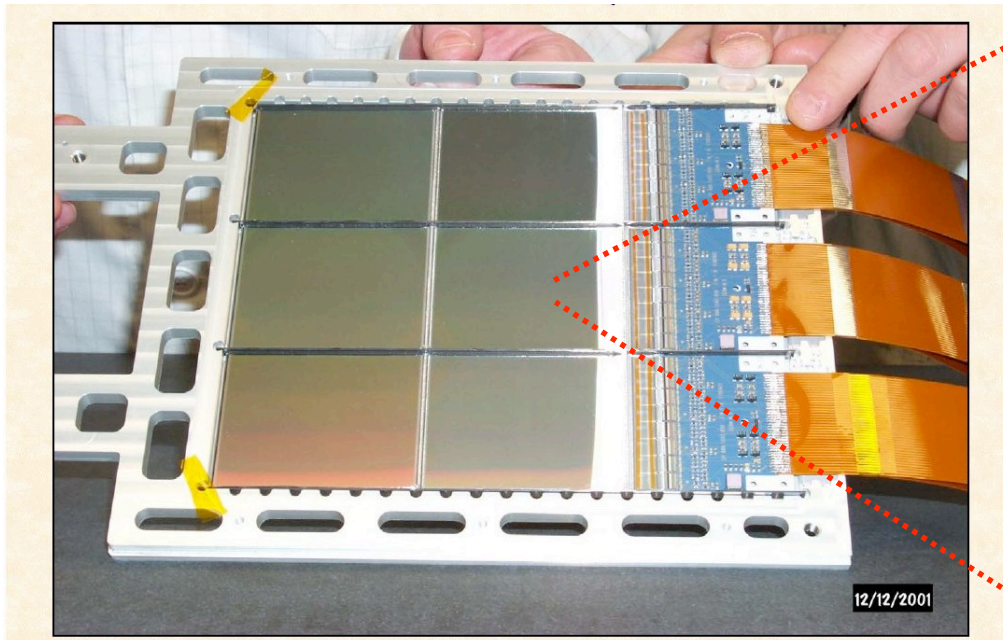

Spectrometer Resolution

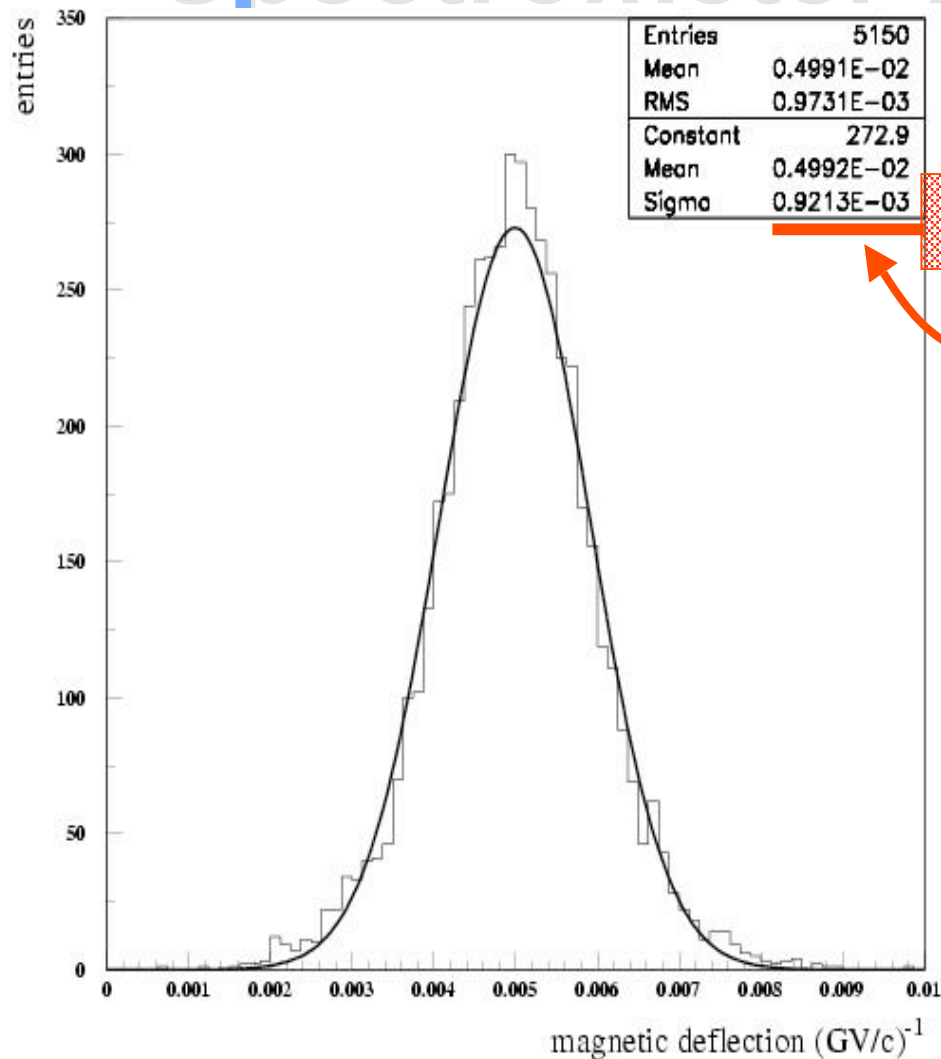

MDR \approx 1080 GV ($\Delta p/p = 100\%$)

- SPS Testbeam data: p 200 GeV/c
 - x (bending = orthogonal to B)
 $\sigma_x = 2.7\mu\text{m}$
 - y (non-bending = parallel to y)
 $\sigma_y = 12\mu\text{m}$
- PAMELA: Magnet

Si-W Imaging Calorimeter

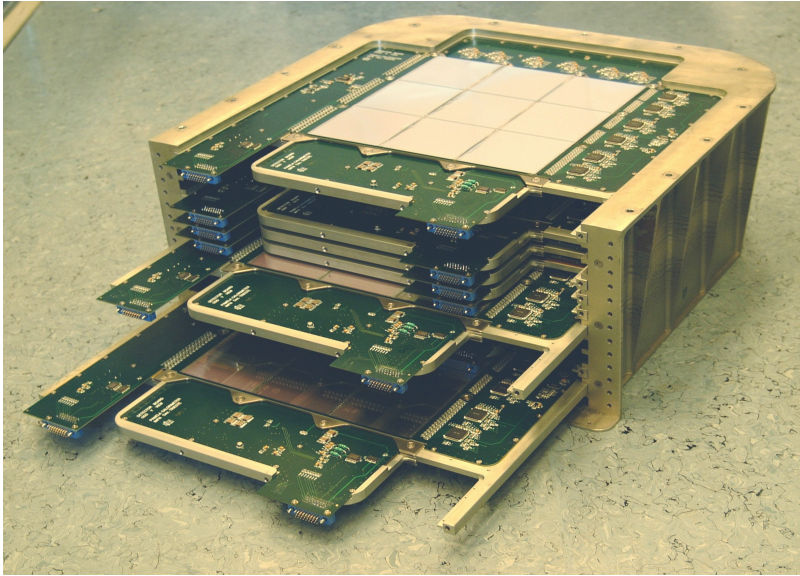

- 22 planes :
- Alternating layers of Si ($380 \mu\text{m}$) / W (2.6 mm)
- 96 strips (2.4 mm wide) per Si layer
- X & Y views
- $16 X_0$ ($0.6 \lambda_N$) deep
- Total number of channels: 4224
- Wide dynamic range \cong
 $1 \div 1000$ MIPs (released charge due to a MIP particle)

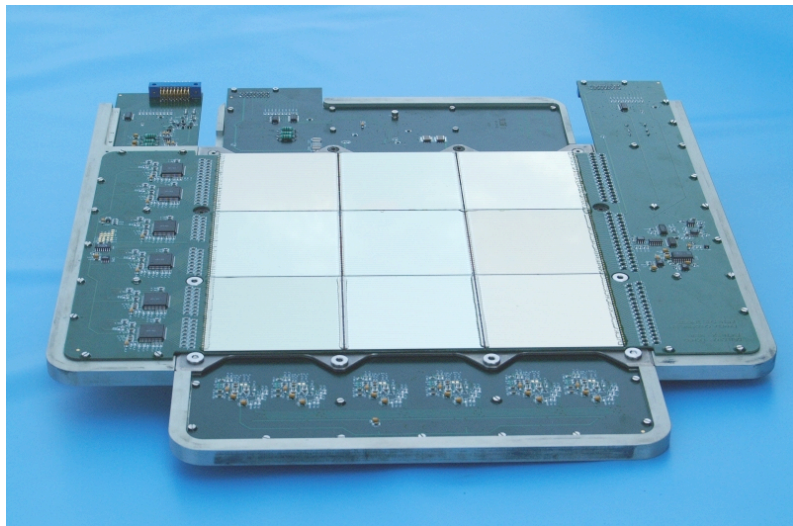

Calorimeter Energy Resolution

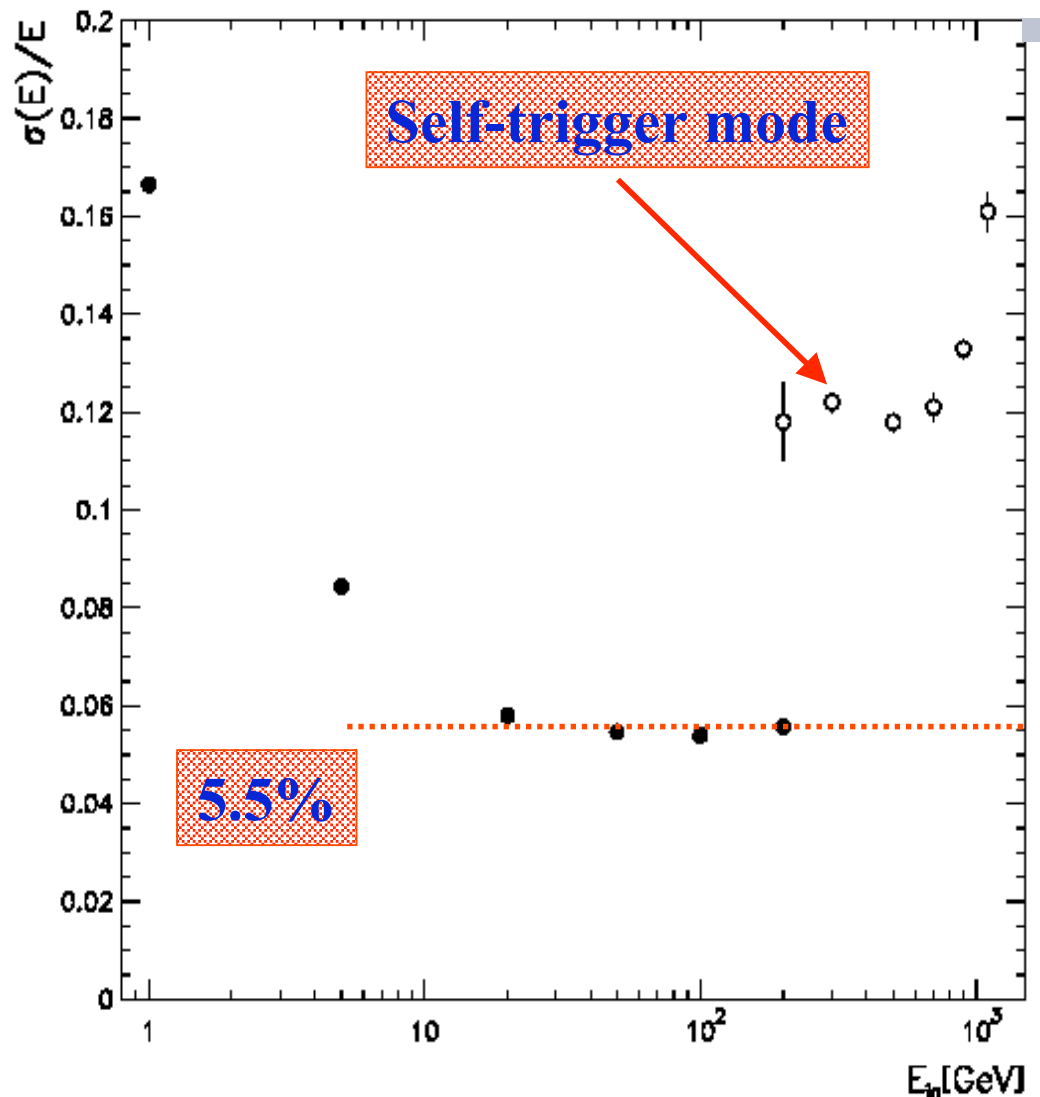

Self trigger mode:

- ~ 300 GeV \rightarrow 2TeV 'electrons'
- Enter one of 1st 4 planes & cross $\geq 10 X_0$
- acceptance: 600 cm²sr
- ♣ Eff($E_e > 300$ GeV) $> 99\%$ (sim.)

e-p Separation with the Calorimeter

- SPS Test
Beam Data:
 - p e⁻
@200 GeV/c
- Proton rejection
factor $\cong 3 \cdot 10^4$
- ♣ Electron selection
efficiency $\cong 95\%$

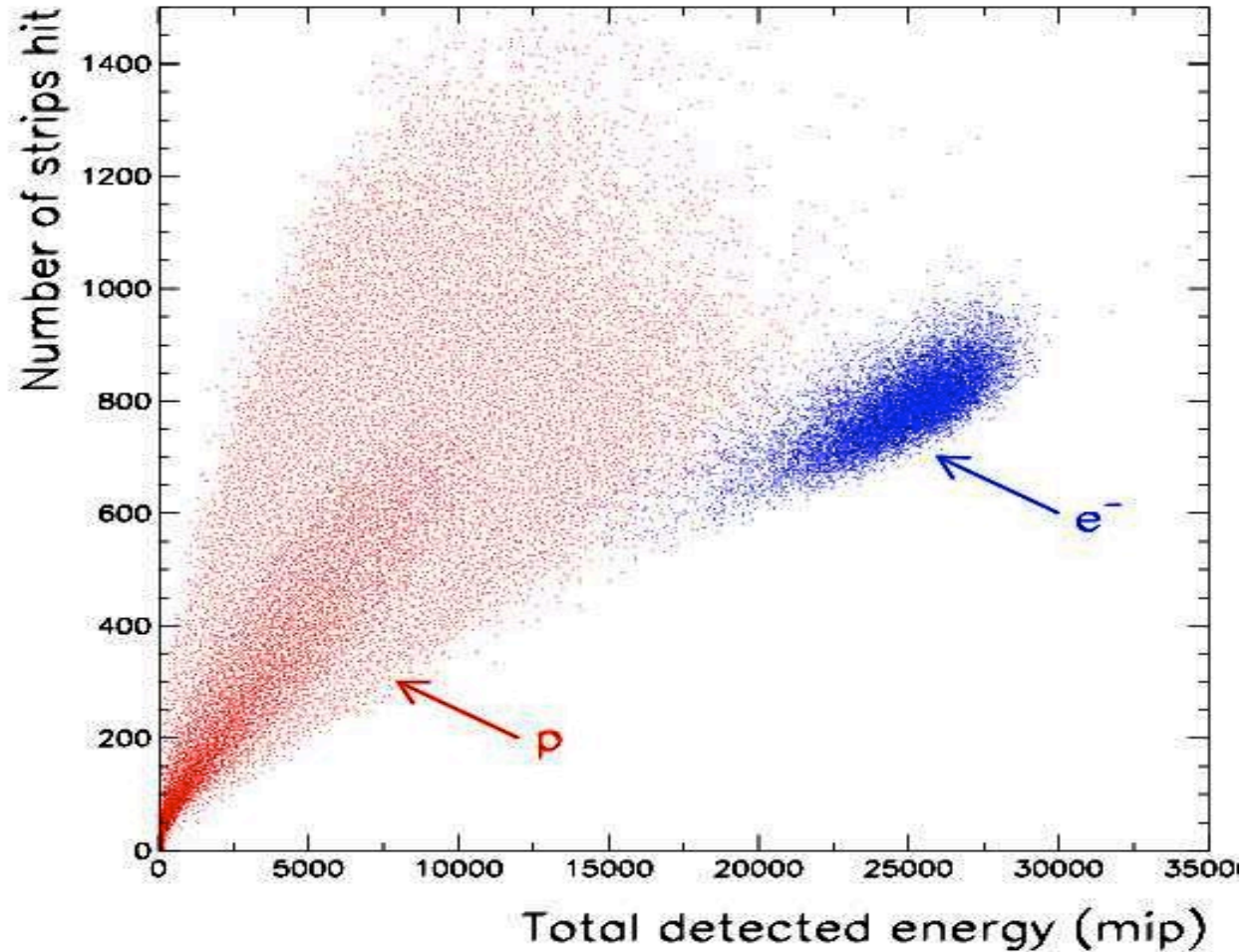

The TOF System

- **TOF:** Particle ID / albedo (from below) rejection
 - 3 planes of Scintillators S1, S2, S3
 - Each plane: 2 crossed layers, segmented into X- and Y- strips
 - Hamamatsu PMT R5900 (selected for Q.E. and to match scintillator strips)
- **TRIGGER:** (S1 x S2 x S3)
- **dE/dx** measurements (charge)

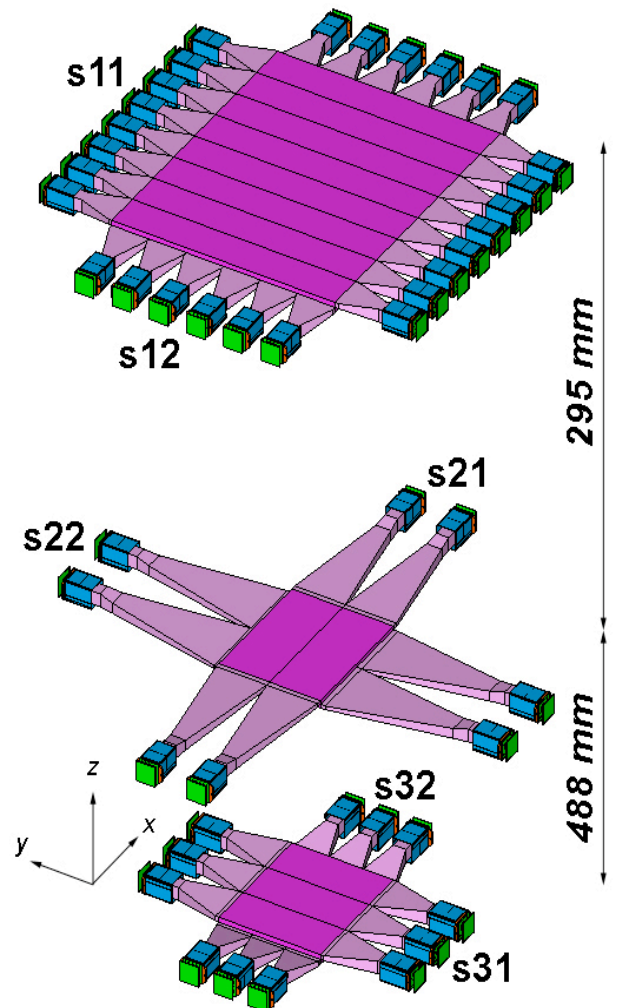
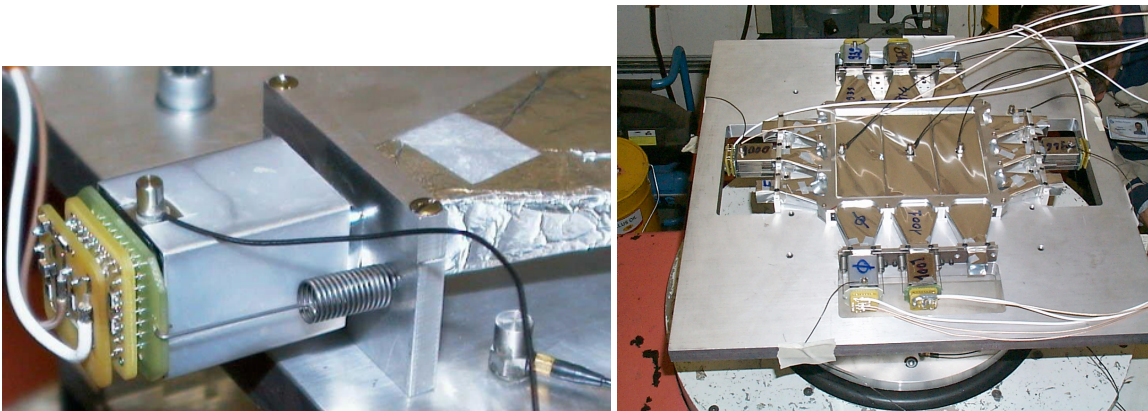

ToF Performance

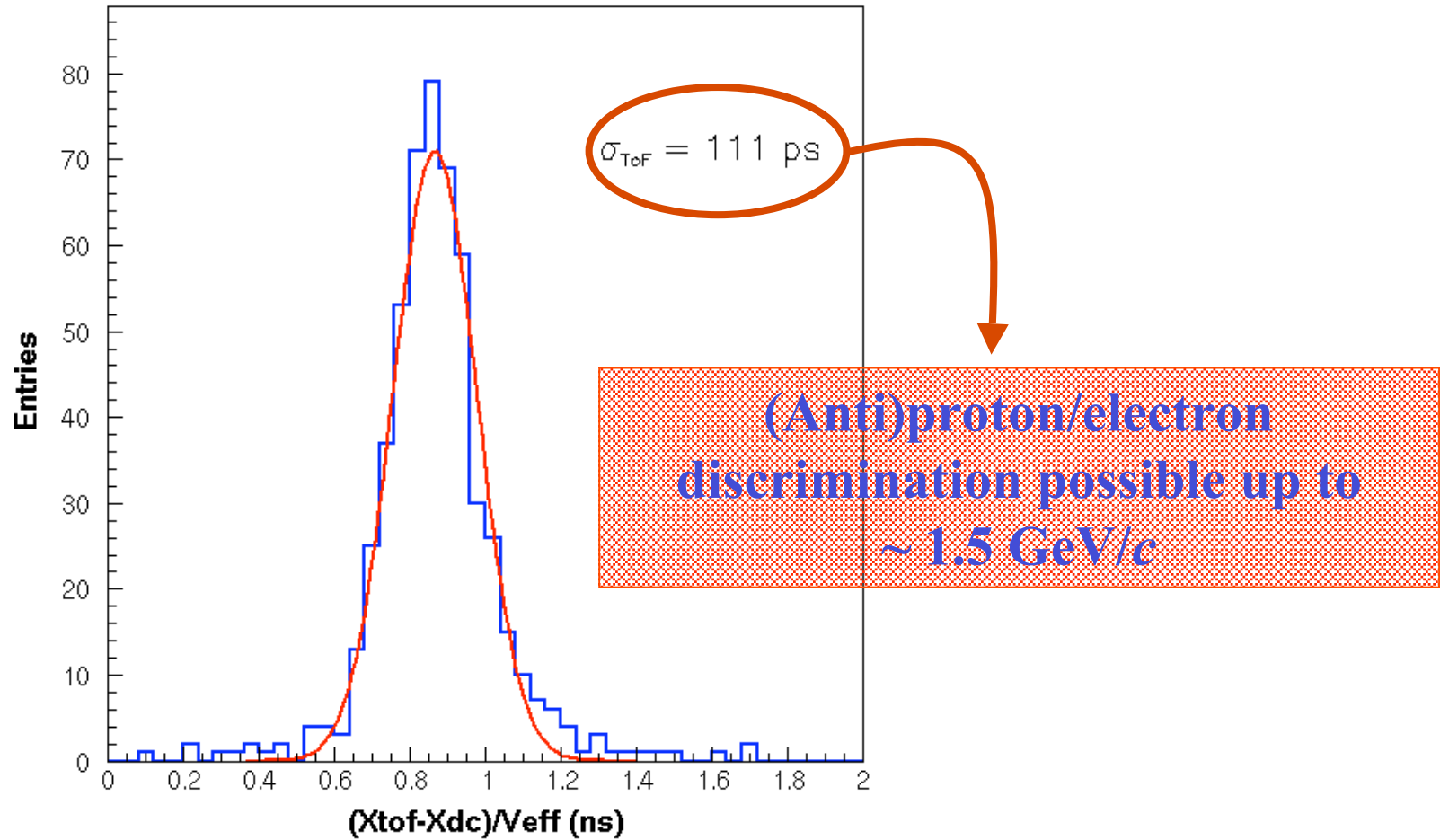

Anticoincidence system

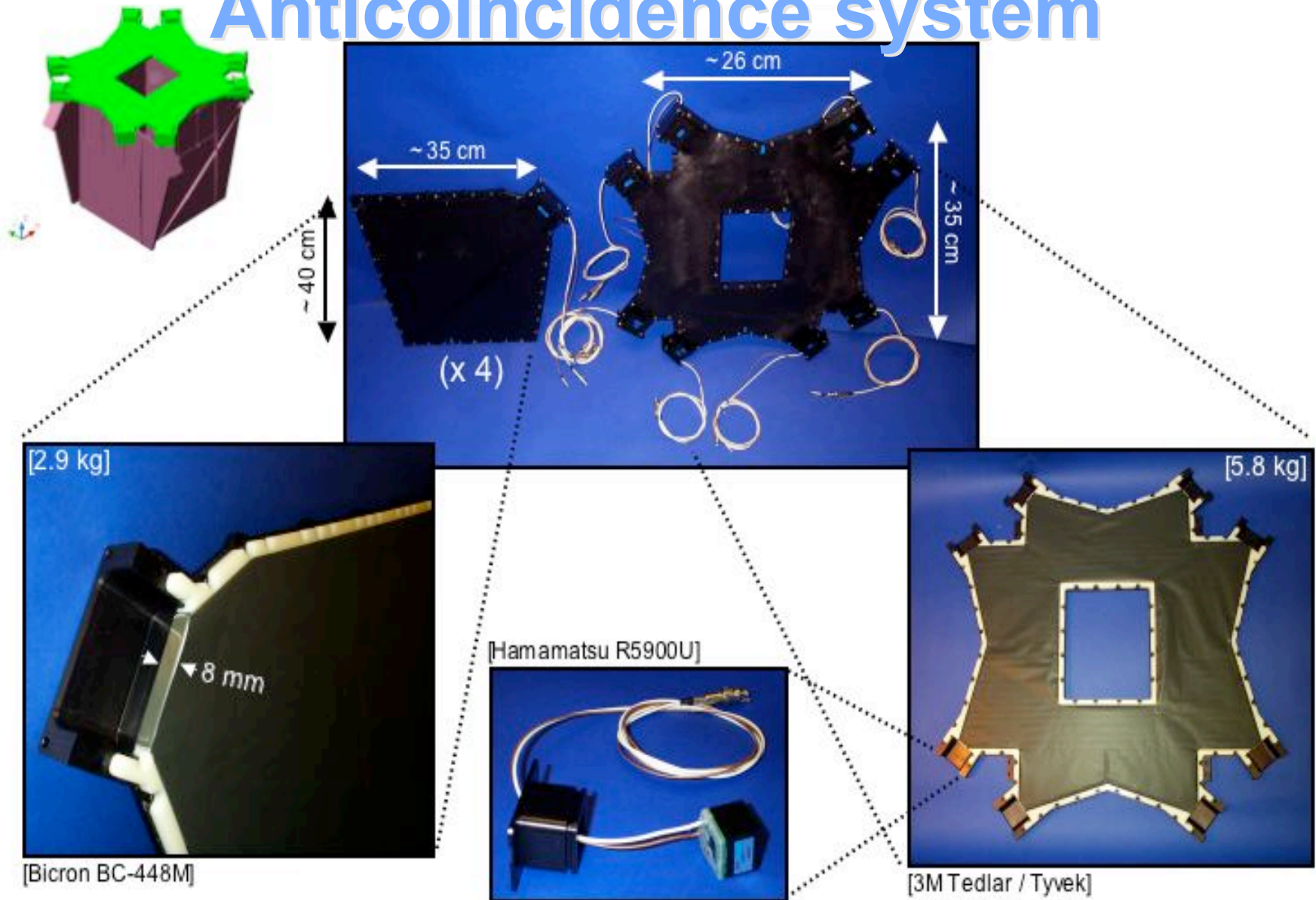

Anticounter Purpose

Good trigger

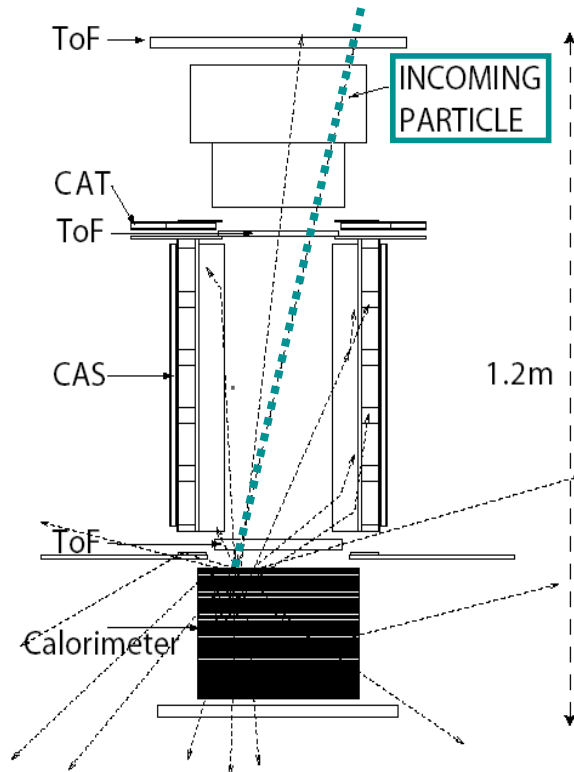

False trigger

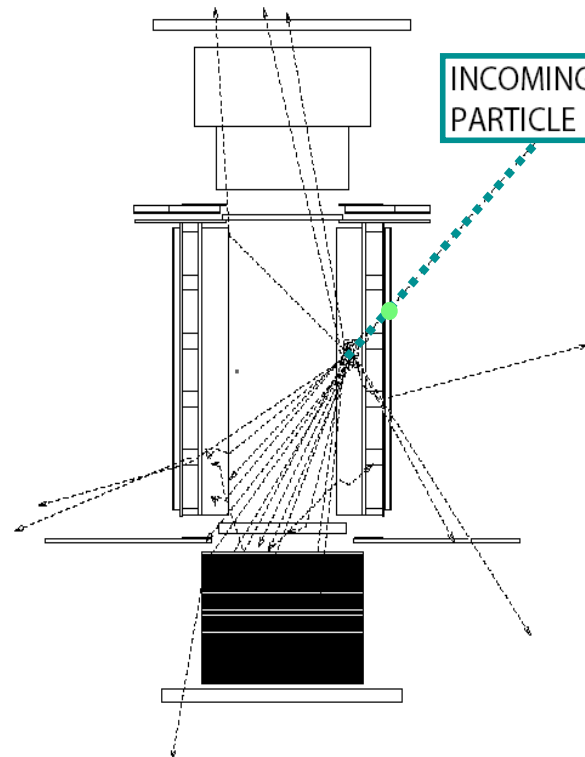

Good trigger with AC self-veto

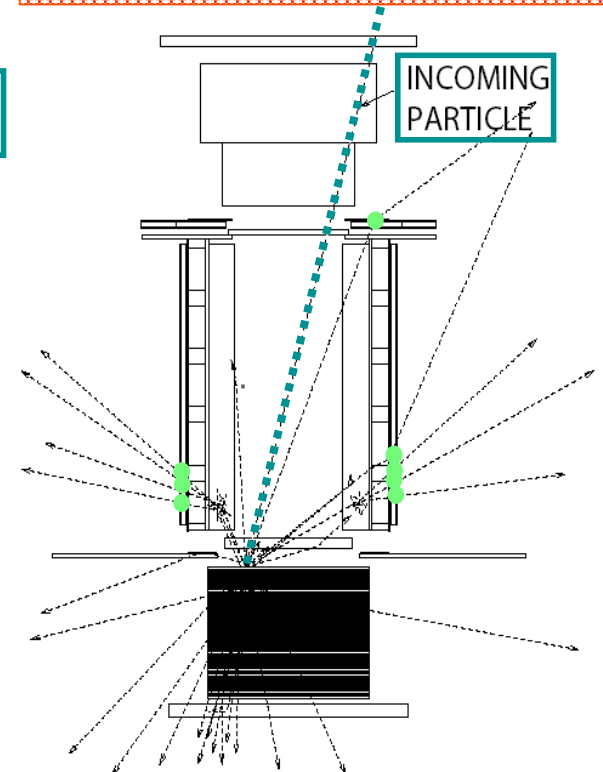

- AC are used offline or in L2 trigger to reduce false triggers

Shower Scintillator & Neutron Counter

- VHE e^\pm , $E \sim 10^{11} \text{ eV} \div 10^{13} \text{ eV}$ using a Neutron Detector (ND) (more n in hadronic than EM showers):
 - $n + {}^3\text{He} \rightarrow p + {}^3\text{H} + 765 \text{ keV}$
- 2 x 18 ${}^3\text{He}$ proportional counters (polyethylene / Cd envelope)

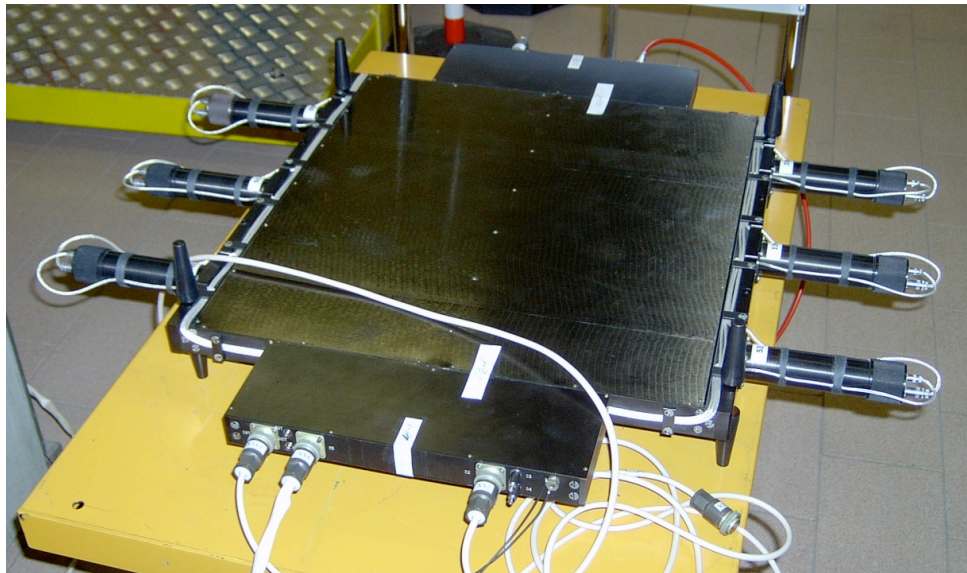

Trigger 

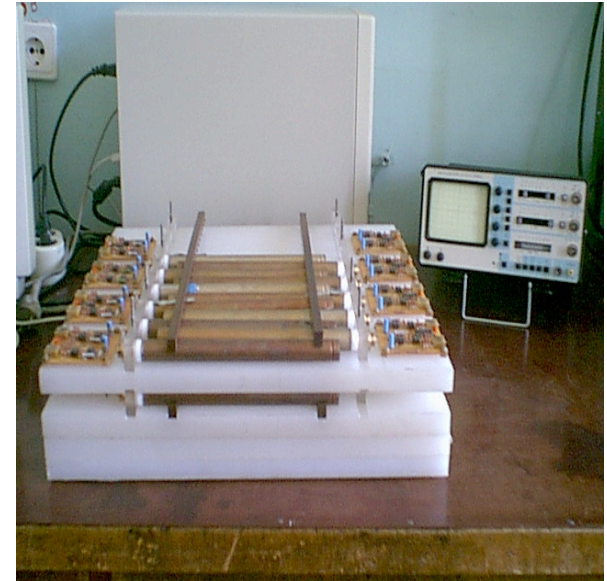

- ND triggered by a plastic scintillator: 482 mm x 482 mm x 10 mm
- 6 PMT read-out
- Dynamic range: 1 \div 1000 MIP



AMS: General

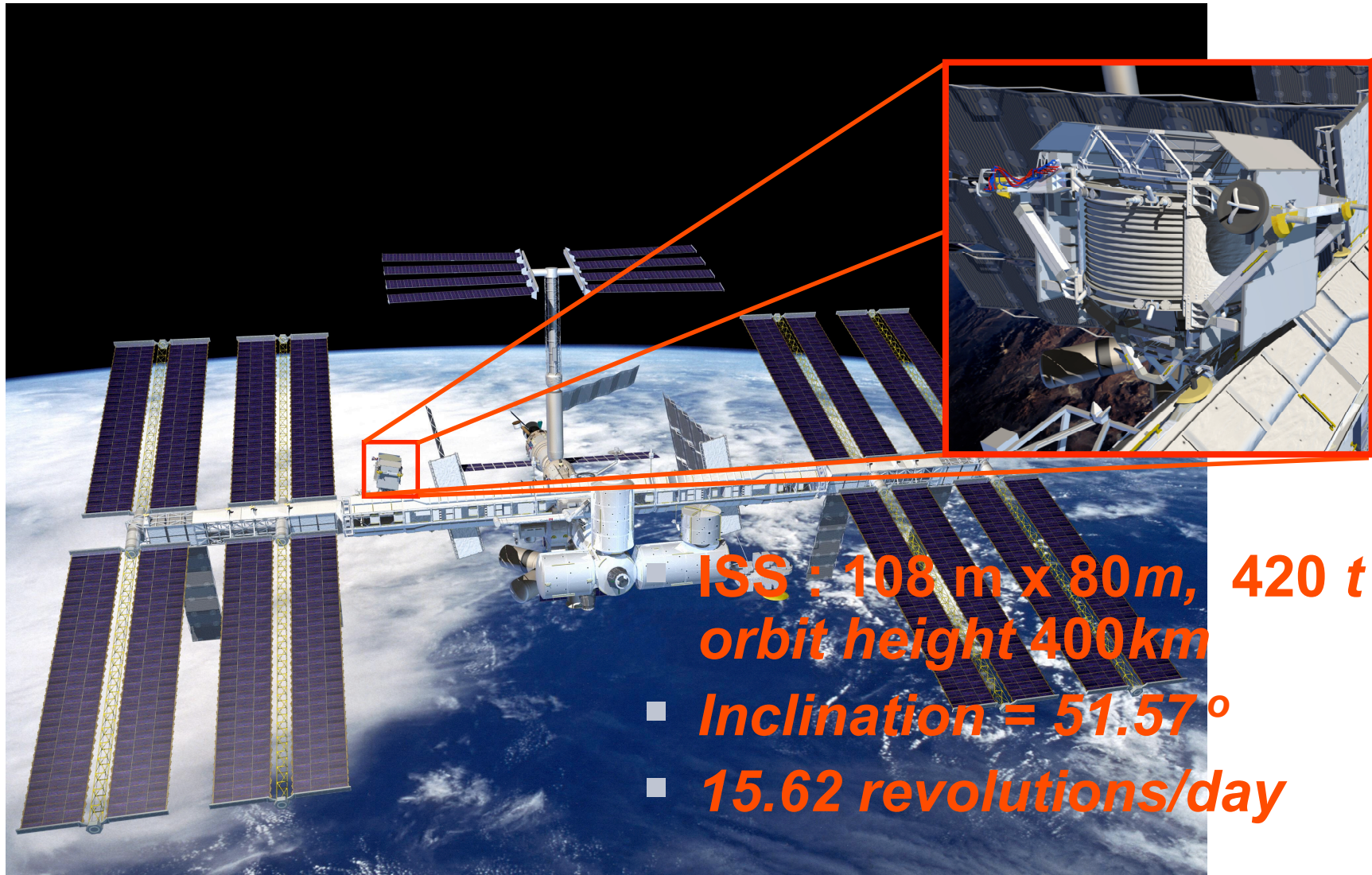

**ISS : 108 m x 80m, 420 t
orbit height 400km**

- ***Inclination = 51.57°***
- ***15.62 revolutions/day***

AMS 02

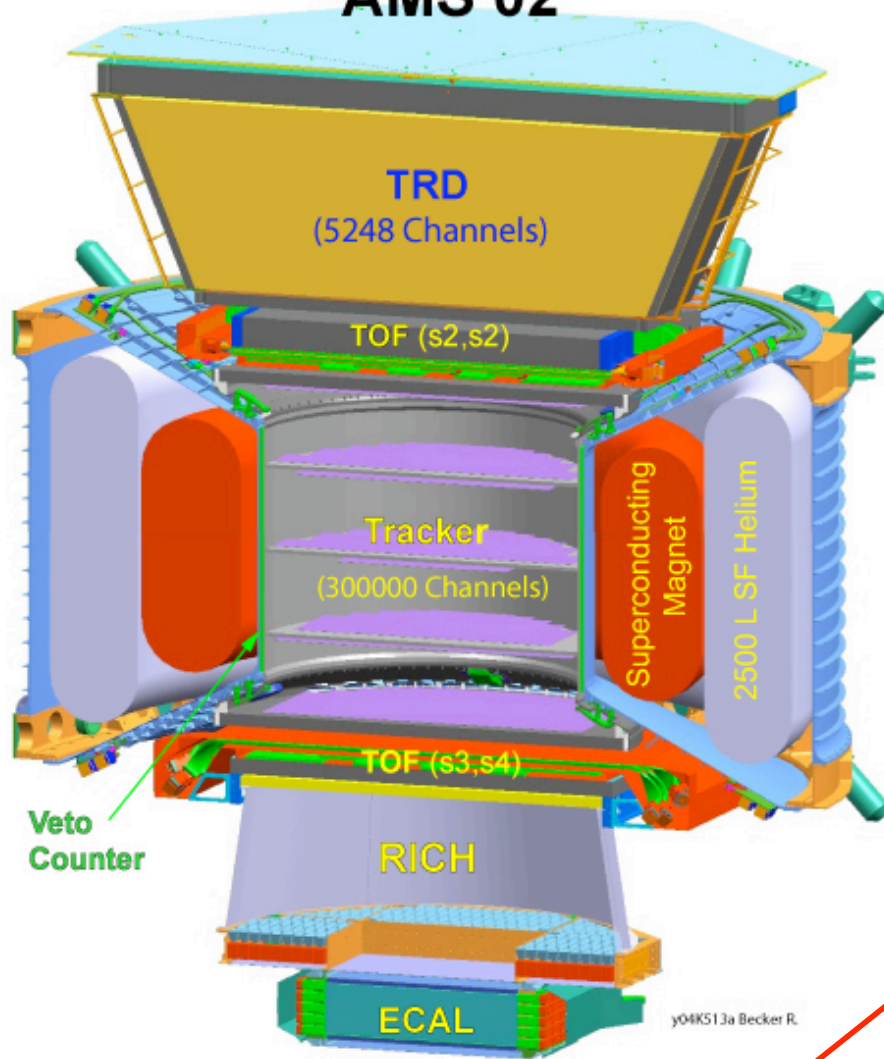

AMS: General

- TRD (e/p)
- Scintillator system (TOF) (β , dE/dx , trigger)
- Superconducting magnet ($BL^2 = 0.85 \text{ Tm}^2$)
- Silicon Tracker (rigidity, charge)
- RICH (β , charge)
- Em. Calorimeter (energy, e/p)

Rigidity meas.

Particle ident.

	e^-	e^+	P	$\bar{\text{He}}$	γ	γ
TRD						
TOF						
Tracker						
RICH						
Calorimeter						

AMS: General



AMS 02 (Alpha Magnetic Spectrometer)

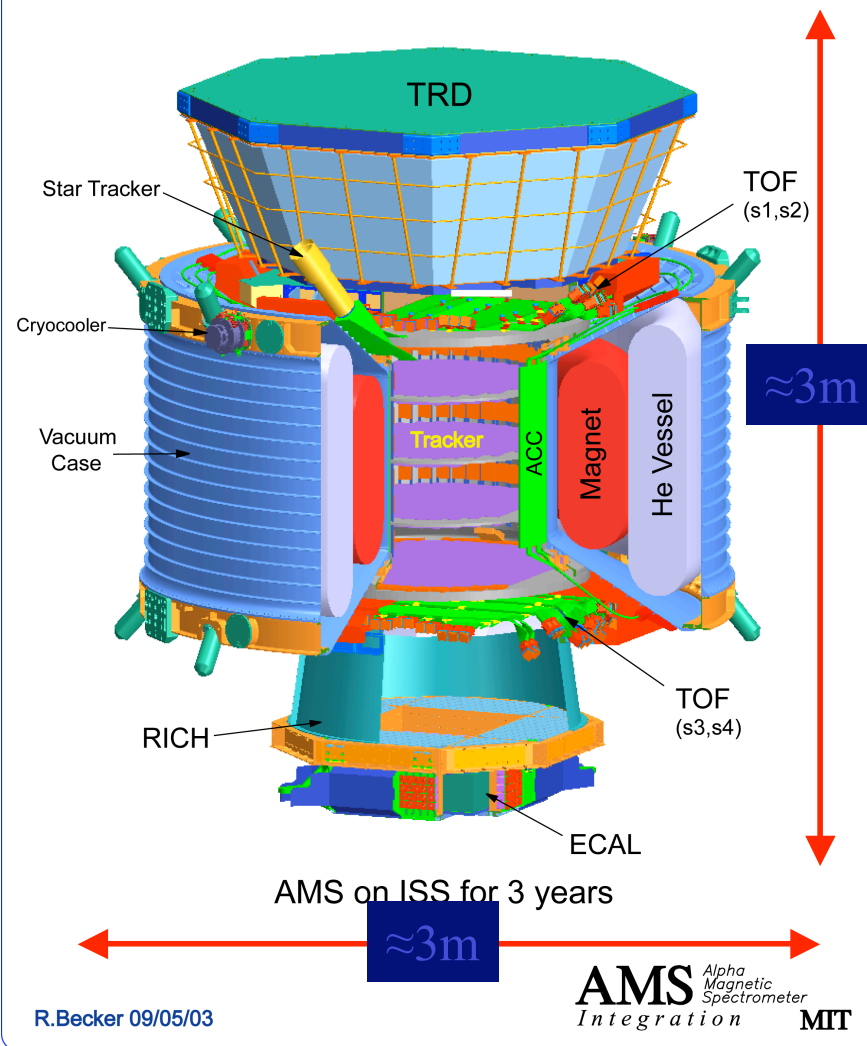

- Large geometrical acceptance: $0.45 \text{ m}^2 \text{ sr}$
- Long exposure: **3 years**
- Redundant measurements
- High vacuum
- High radiation levels
- Strong gradients of temperature $-60^\circ\text{C} \div +40^\circ\text{C}$
- Weight < **7 Tons**
- Power consumption < **3kW**



Superconducting Magnet

racetrack coils

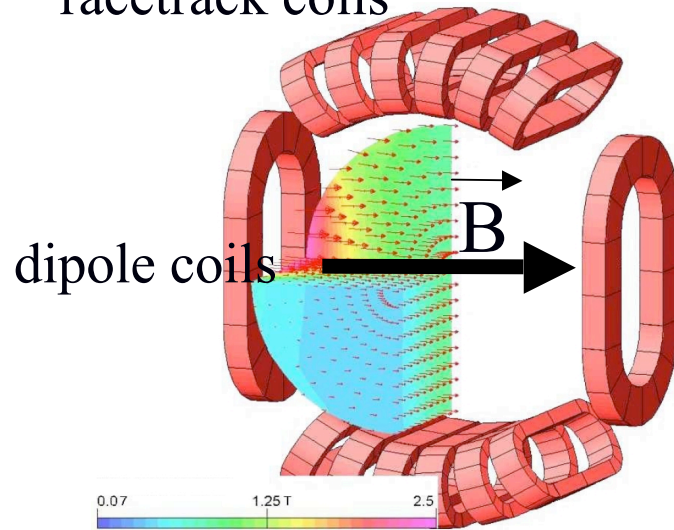

dipole coils

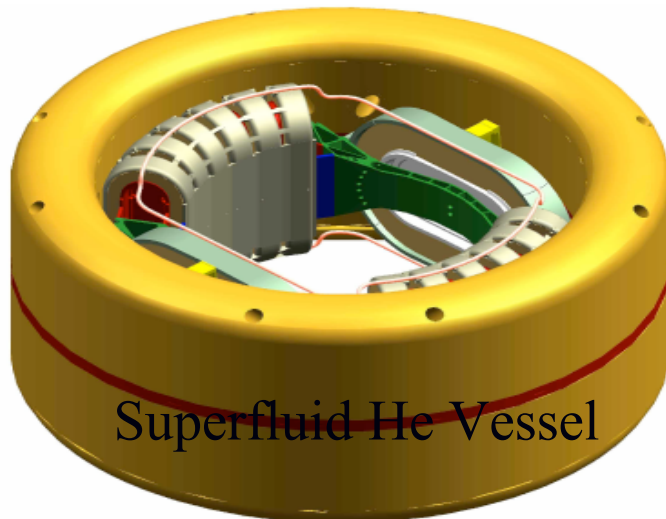
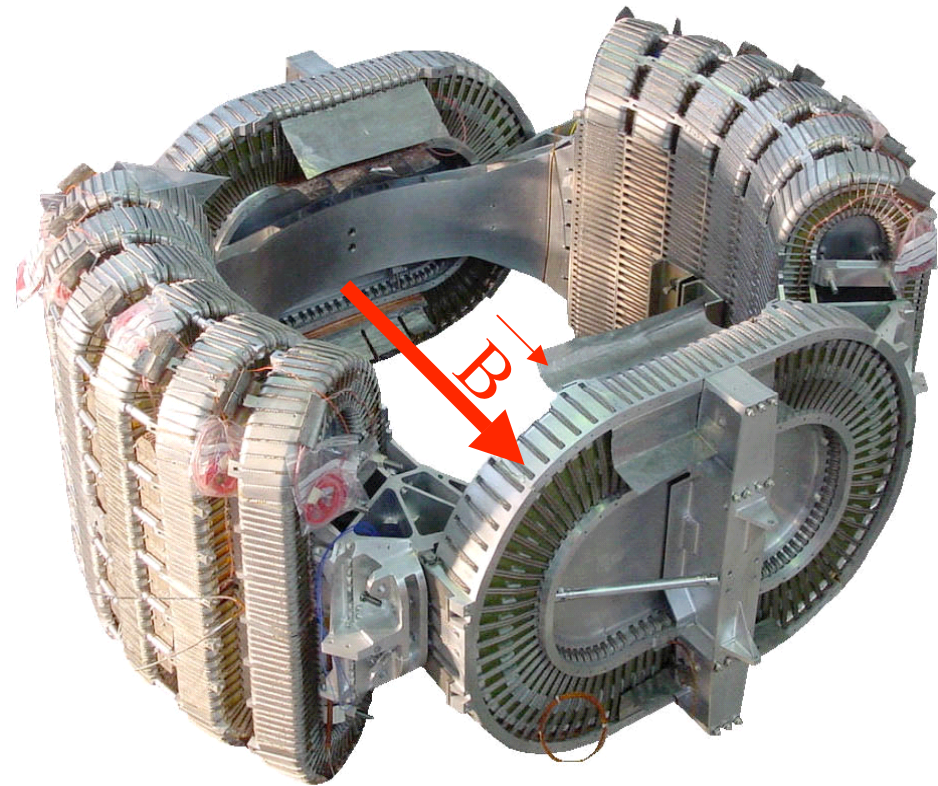

Superfluid He Vessel

Chan Hoon Chung, RWTH-Aachen, Germany

Diameter = 1.2 m, Height = 0.8 m, Weight = 2.3 t
 $B_{\text{dipol}} = 0.860$ [T], $E_{\text{stored}} = 1.15$ MJ, $I = 459.5$ [A]
Cold Heat Exchanger : Superfluid Helium
(-271.35°, 2500 l)

Long Duration Operation without refill

AMS: Tracker

- 2264 Double sided Silicon wafers
- 640 readout strips on implantation or p-side (bending coordinate)
- 384 readout strips on junction or n-side (non-bending coordinate)
- Combined into 192 Ladders of 7-15 sensors
- 1024 readout channels for each ladder, total of ~ 200k channels
- Ladders arranged on 8 layers piled up in 5 planes
- ~ 6.4m² total

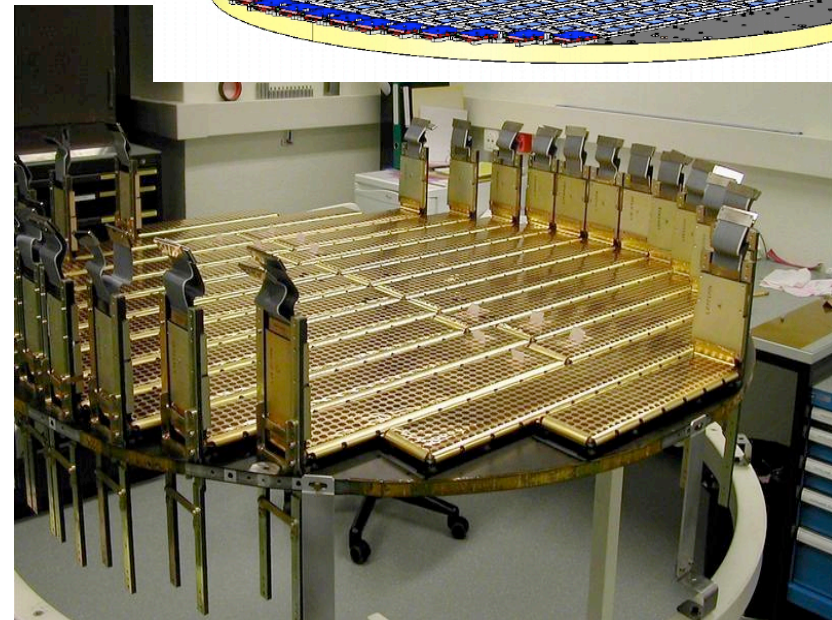
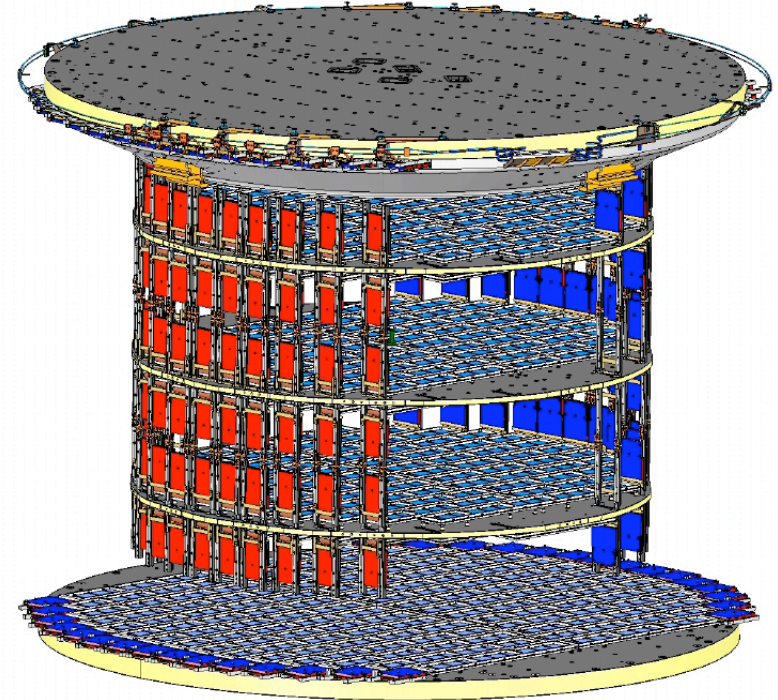

AMS: Tracker

MDR \cong 3000GV ($\Delta p/p = 100\%$)

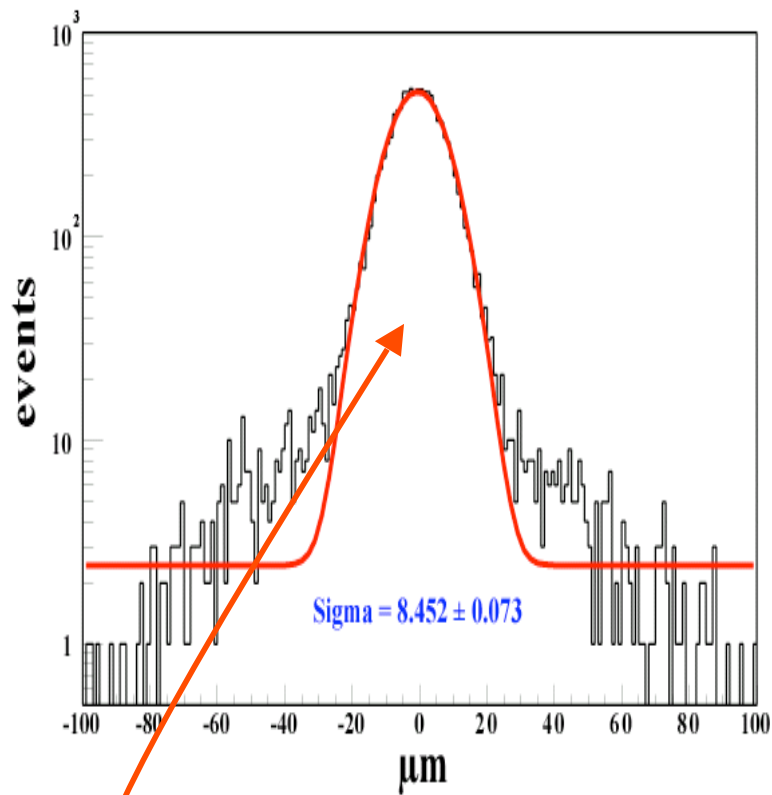

Spatial resolution $\sim 10\mu\text{m}$

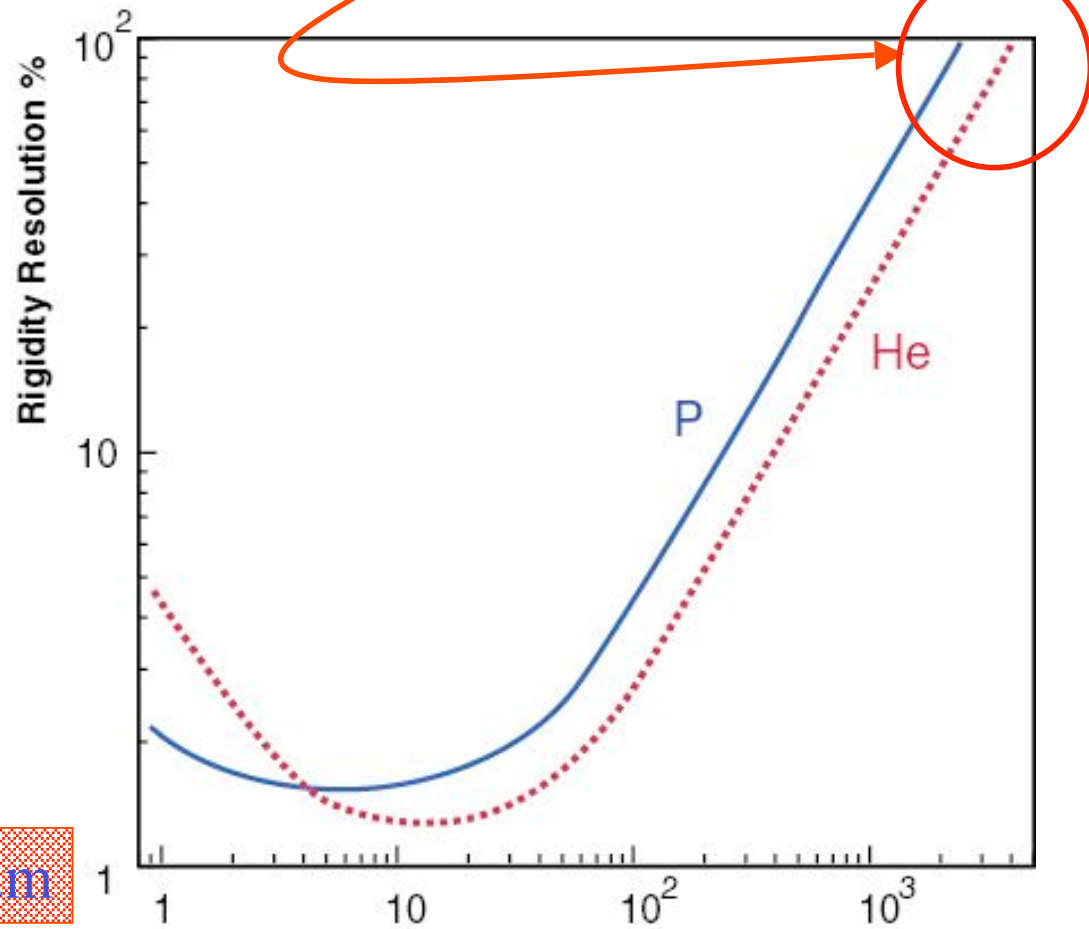

120 GeV/c muon beam

Upper ToF

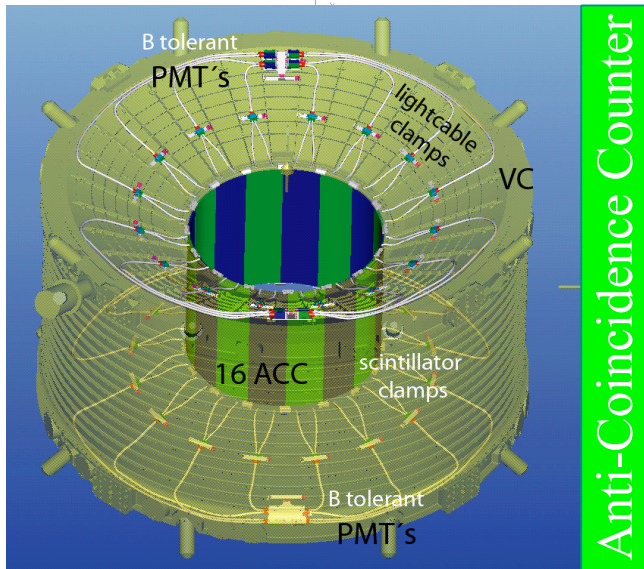
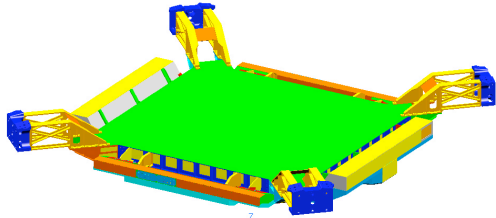

Anti-Coincidence Counter

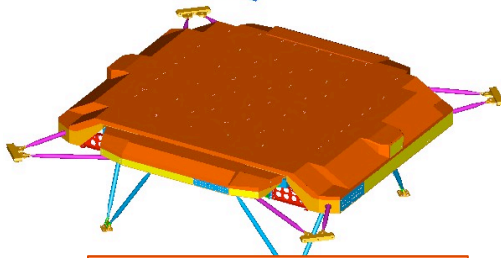
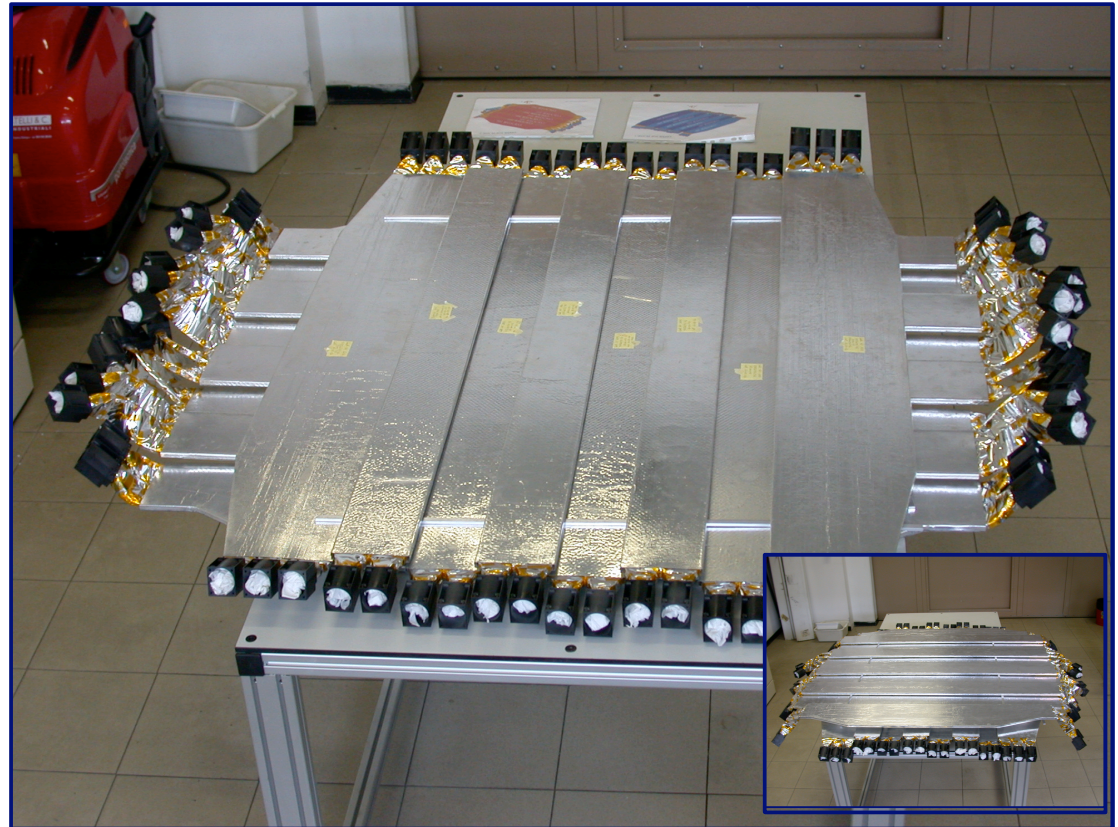

Lower ToF

Fast Trigger_{prim} $\sigma_t \leq 130$ [ps]
 Layers = 4 (2 + 2) Area = 8 m²
 ToF : 34 Paddles
 ACC : 16 Cylindrical Shell Paddles

AMS: Em. Calo.

- 9 Superlayers (Pb + Fiber Sandwich)
- $16.4 X_0$ and $\sim 0.5 \lambda_{\text{nucl.}}$
- Standalone Gamma Trigger
- $65 \times 65 \text{ cm}^2$, $m = 640 \text{ kg}$, 324 PMTs

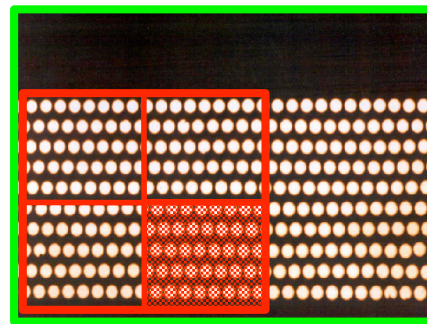
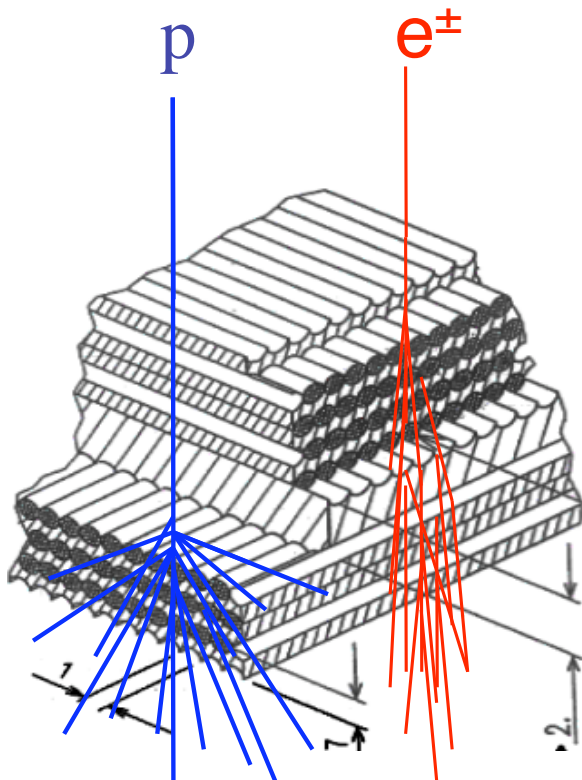
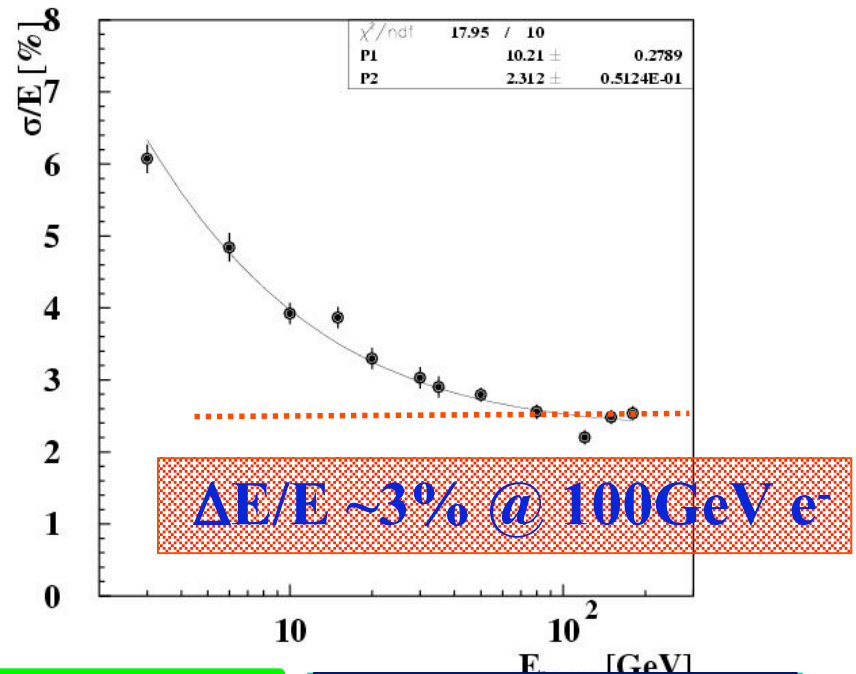

Lead foil ($t: 1 \text{ mm}$)

Fibers ($\phi: 1 \text{ mm}$)

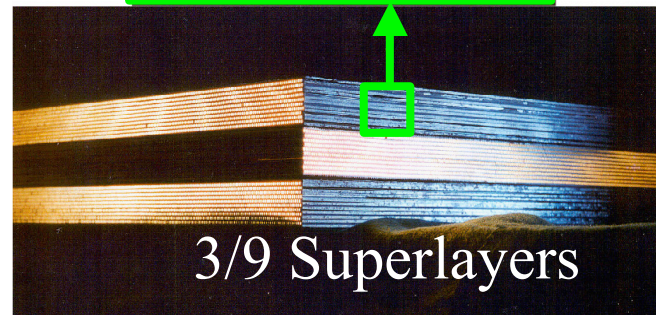

3/9 Superlayers

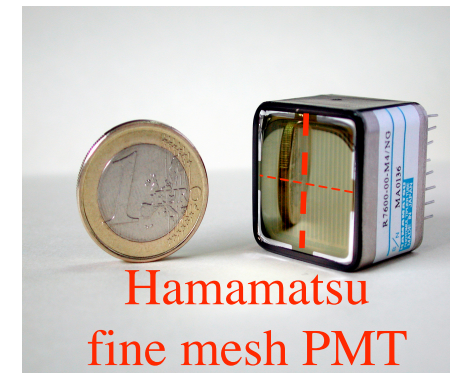

Hamamatsu
fine mesh PMT

AMS: TRD

- 2.2x 2.2x0.8 m³ , 350 kg, 20 layers of straw tubes. Radiator: 2 cm polyethylene/ polypropylene 10 mm fibre fleece. Gas mixture is Xe:CO₂ 80:20% (1 bar)
- Conical octagon structure made of aluminum honeycomb with carbon-fibre skins and bulkheads
- Mechanical precision: 100 mm to assure gas gain homogeneity below 2%
- 4 lower and upper oriented parallel to the magnetic field, middle 12 perpendicular to it, for 3D tracking

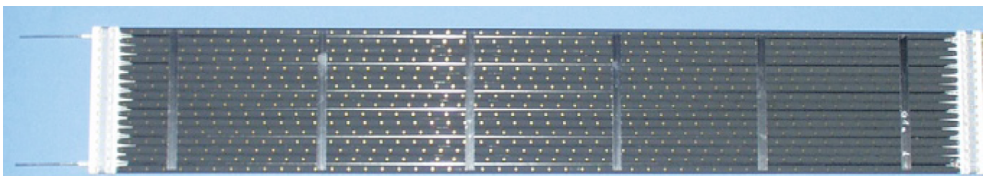
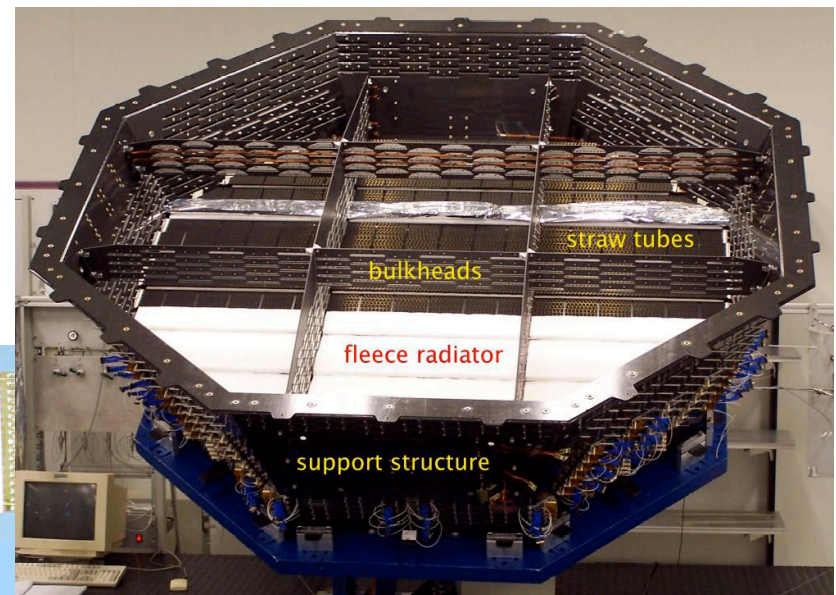
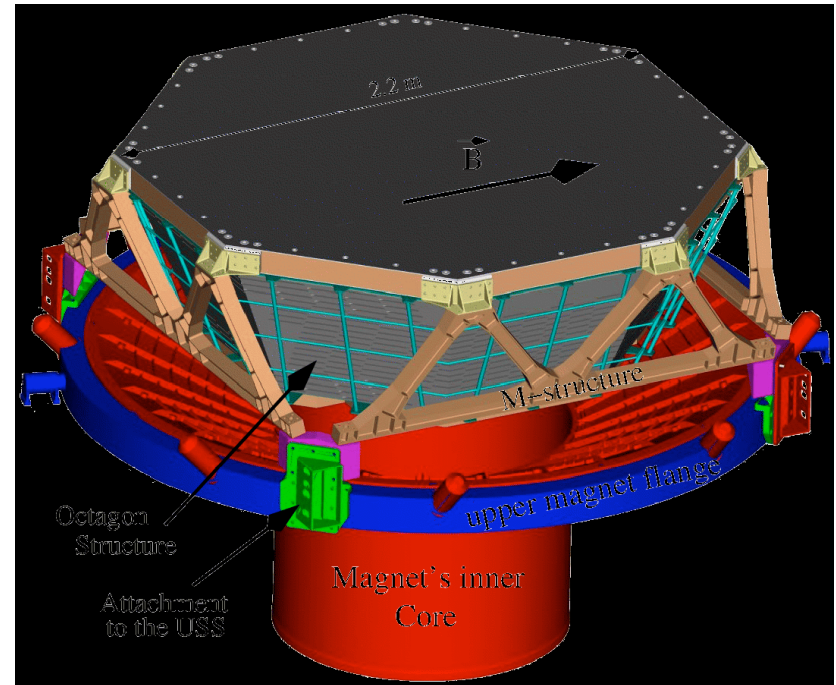

One of 328 Straw Modules

AMS: TRD

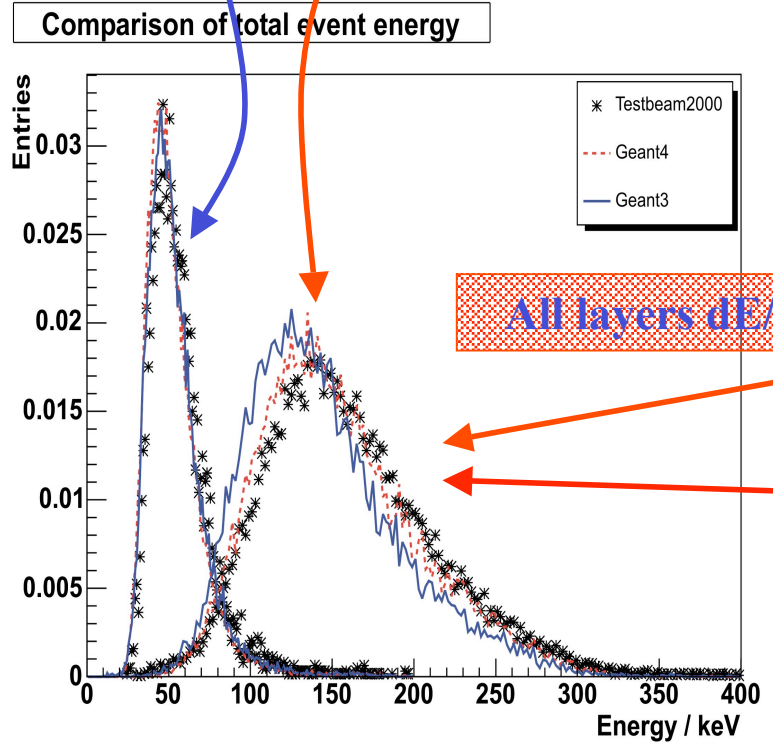
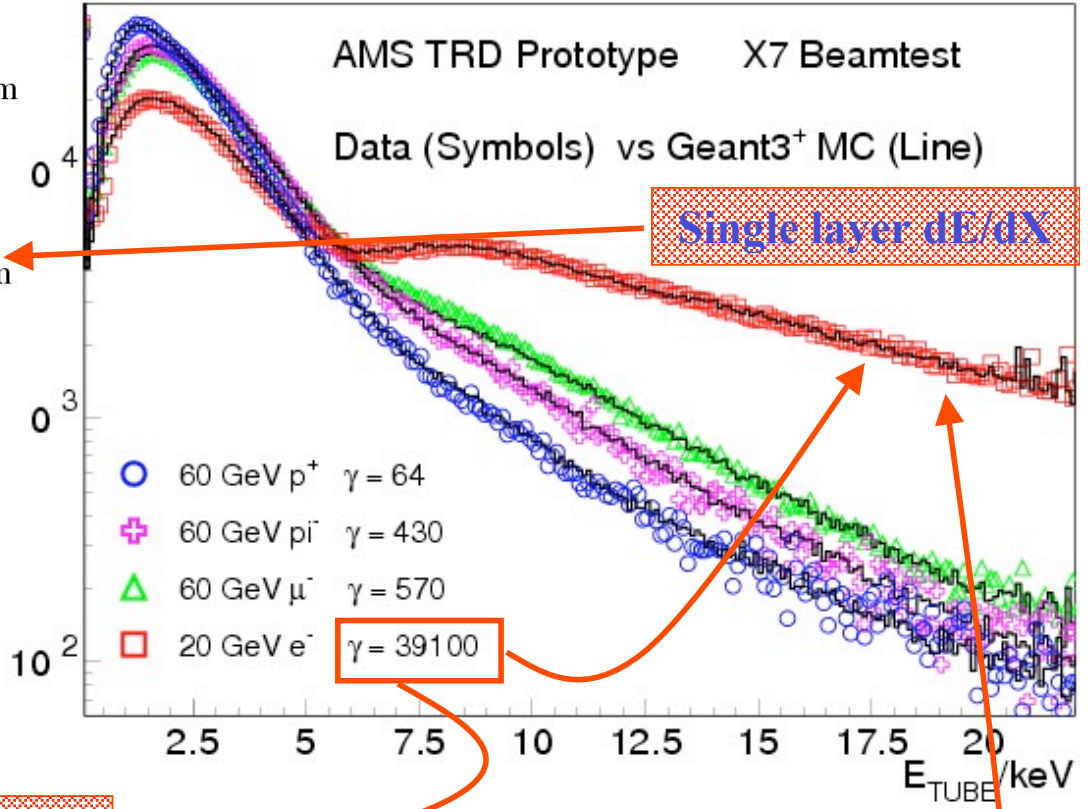
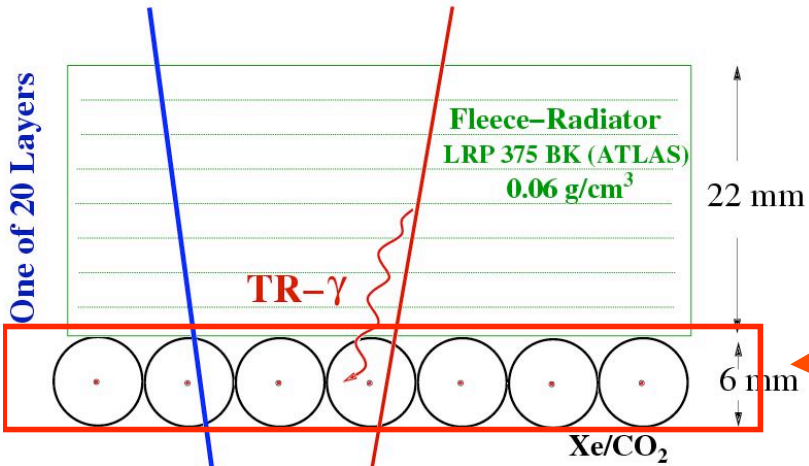

All layers dE/dX

Tails due to X-rays emission.
High Lorentz factor

AMS: Rich

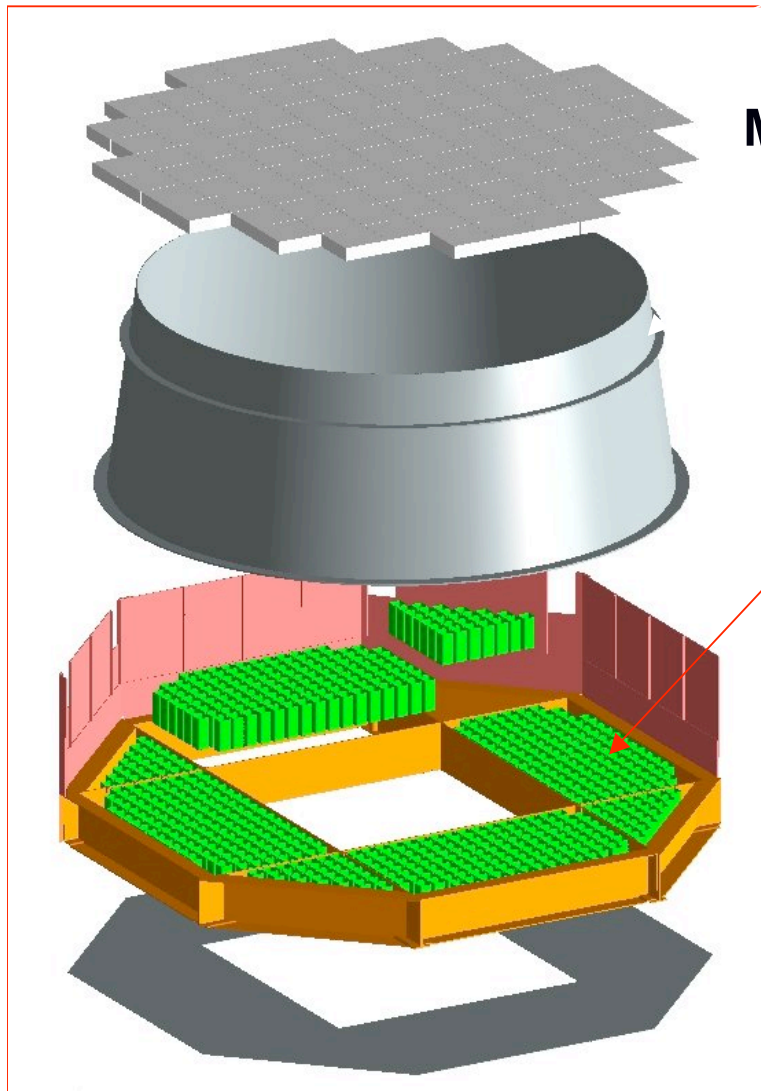

Radiator (Aerogel and NaF)

Cerenkov Cone

Mirror

PMTs Array

$$\cos\theta_c = 1/(\beta n)$$

- Rad. NaF ($n=1.336$) in central region and Aerogel ($n=1.035$) elsewhere
- 680 PMT's Array, Spatial Pixel 8.5×8.5 mm²
- Velocity Res.: $\Delta\beta/\beta = 0.07\%$ ($Z=1$)
- Charge Measurement: $Z \leq 26$ (w/ Tracker + ToF)
- Charge $N_\gamma \sim Z^2 \Delta L \sin \Theta_C$
- Mass: $m(\beta, Z, R) = p/c \times \sqrt{n^2 \cos^2 \Theta_C - 1} = (pc/Ze) \times Ze/c^2 \times \sqrt{1-\beta^2}/\beta = RZe \times \sqrt{1-\beta^2}/\beta c^2$

AMS: Rich

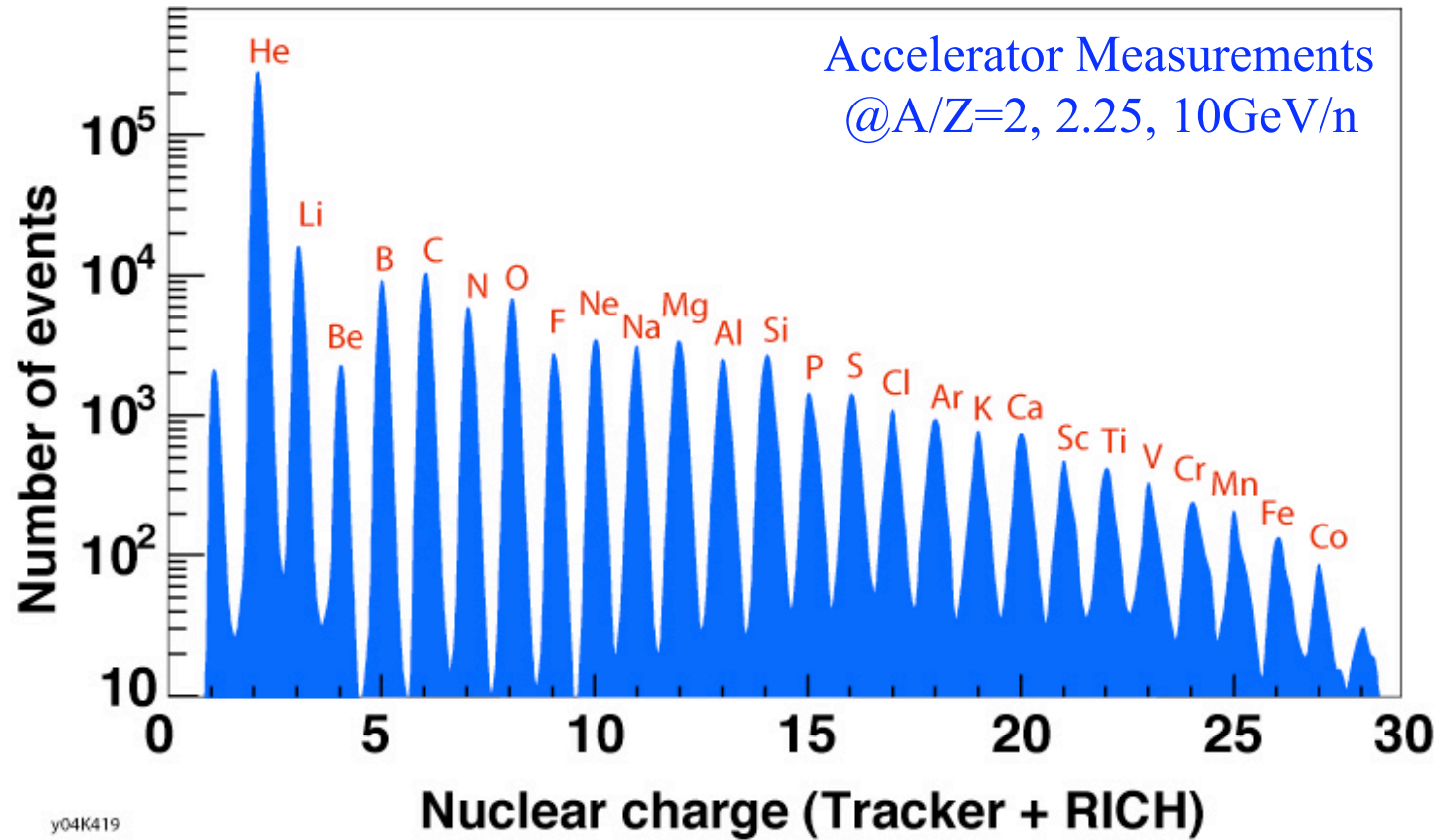

Charge measurement

TOF Tracker: Sampling of particle energy deposition $\Delta E \propto Z^2$

RICH: The number of Cerenkov radiated photons when a charged particle crosses a radiator path ΔL , depends on its charge Z

$$N \propto Z^2 \Delta L \left(1 - \frac{1}{\beta^2 n^2} \right)$$

Their detection on the PMT matrix close to the expected pattern depends on:

- radiator interactions (ϵ_{rad}):
 - absorption and scattering
- photon ring acceptance (ϵ_{geo}):
 - photons lost through the radiator lateral and inner walls
 - mirror reflectivity
 - photons falling into the non-active area
- light guide losses (ϵ_{lg})
- PMT quantum efficiency (ϵ_{pmt})

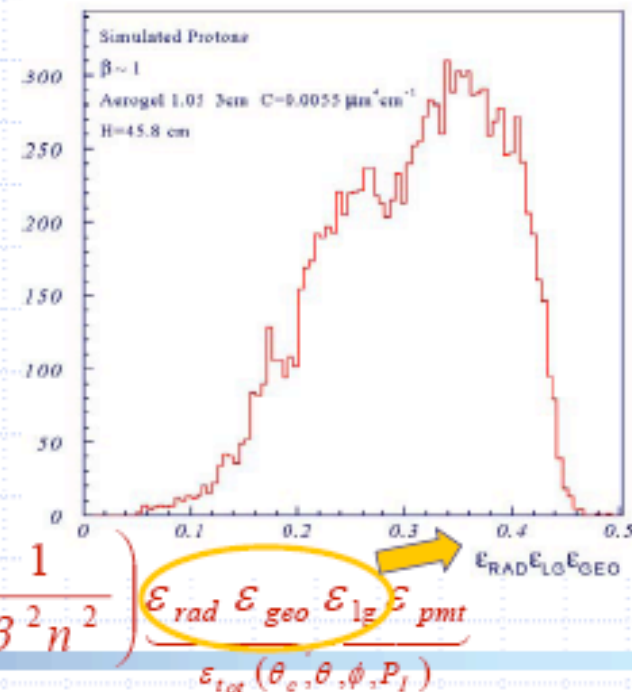

$$N_{pe} \propto Z^2 \Delta L \left(1 - \frac{1}{\beta^2 n^2} \right) \underbrace{\epsilon_{\text{rad}} \epsilon_{\text{geo}} \epsilon_{\text{lg}} \epsilon_{\text{pmt}}}_{\epsilon_{\text{tot}}(\theta_e, \theta, \phi, P_f)}$$

RICH velocity measurement (β): a prototype (96 PMTs) was tested

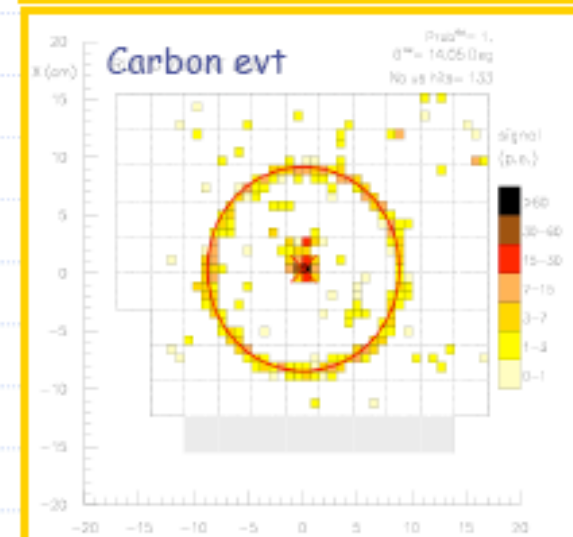
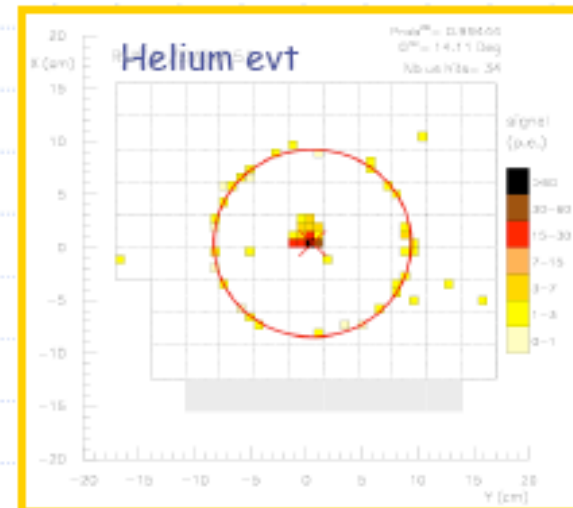
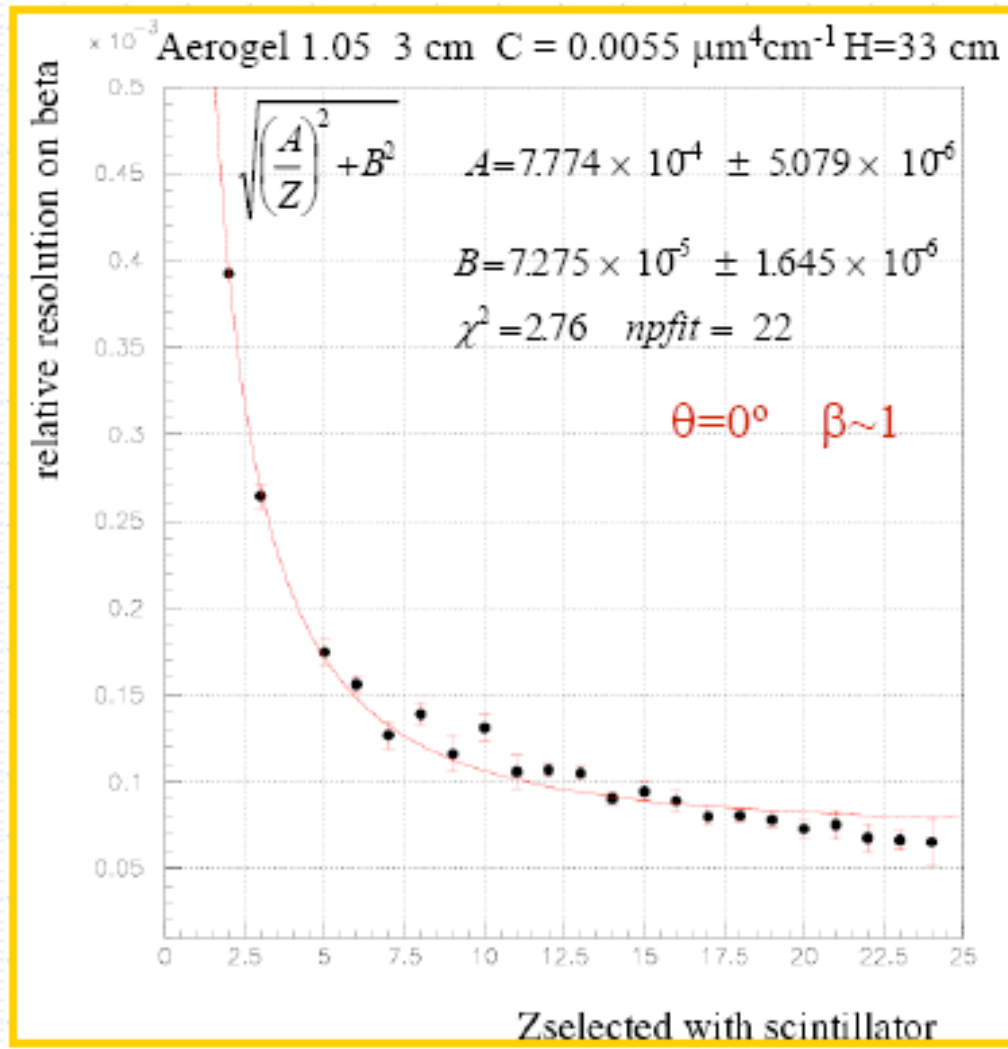

The BESS experiment

Balloon-borne Experiment with Superconducting Spectrometer

Joint project of Japanese and USA Institutions to search for antimatter in the cosmic radiation

<http://bess.kek.jp/>

<http://universe.gsfc.nasa.gov/astroparticles/programs/bess/>

Last flight: 8 days from McMurdo (Antartica) in Dec 2004



BESS detector:

- Top and bottom ToF scintillators that also measure the particle energy loss
- Aerogel Cherenkov counter mounted under the top ToF
- 2 inner drift chambers (IDC) inside the magnetic field space
- Central tracking device in magnetic field region made of JET type drift chambers

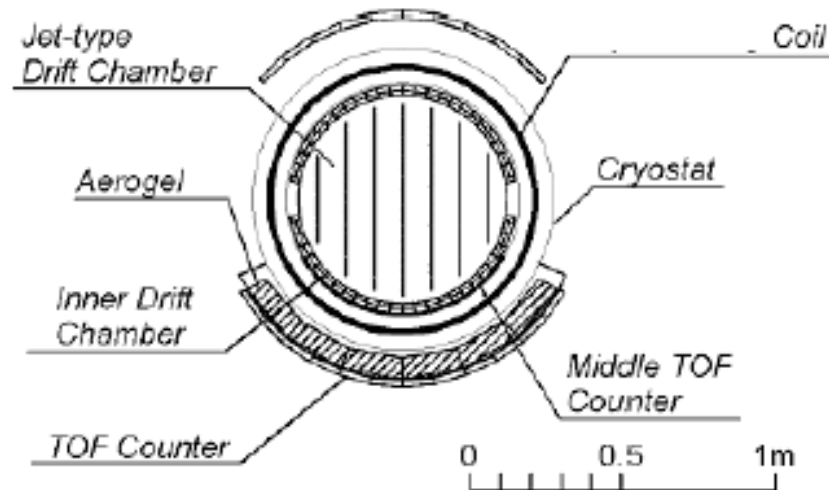

Finally CAPRICE 98 !

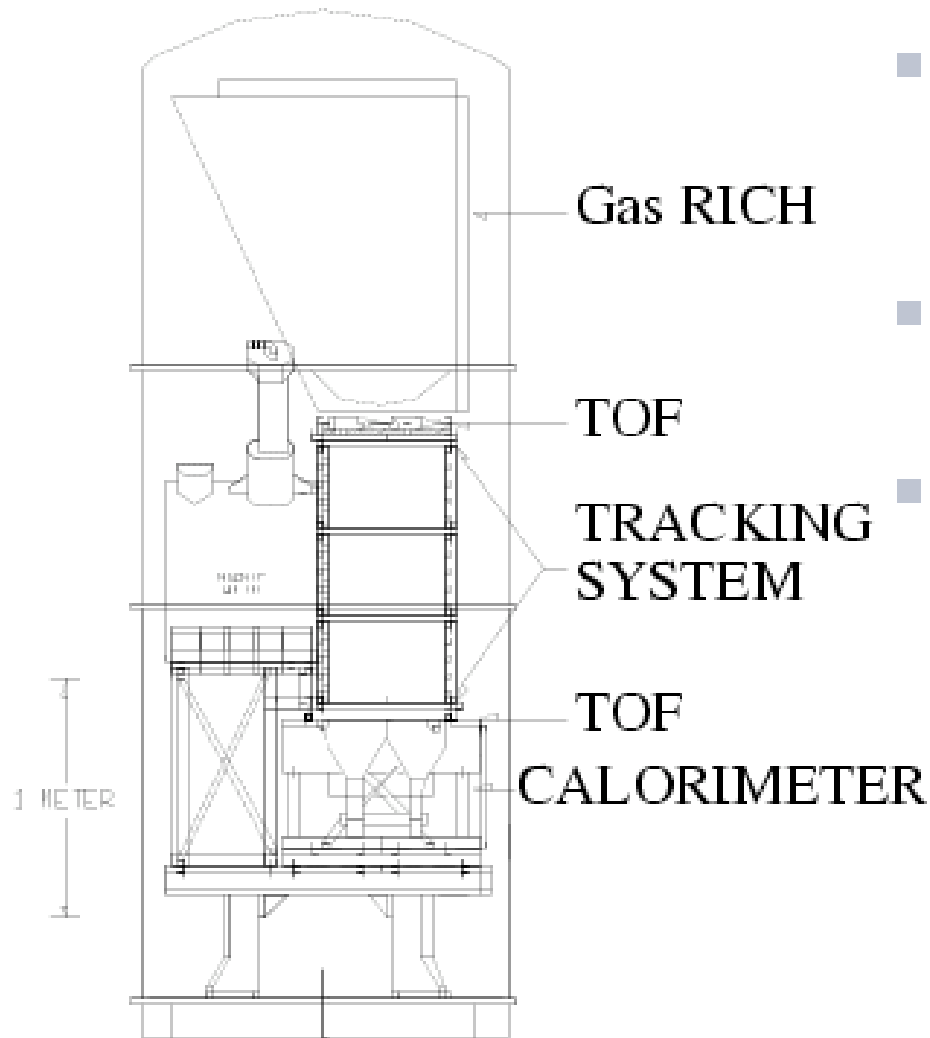

- For the first time a **GAS RICH** together with a **Silicon calorimeter**.
- **Mass resolved \bar{p}** for **$E > 18$ GeV**
- **Redundancy and cross-measurements**

In flight Performances

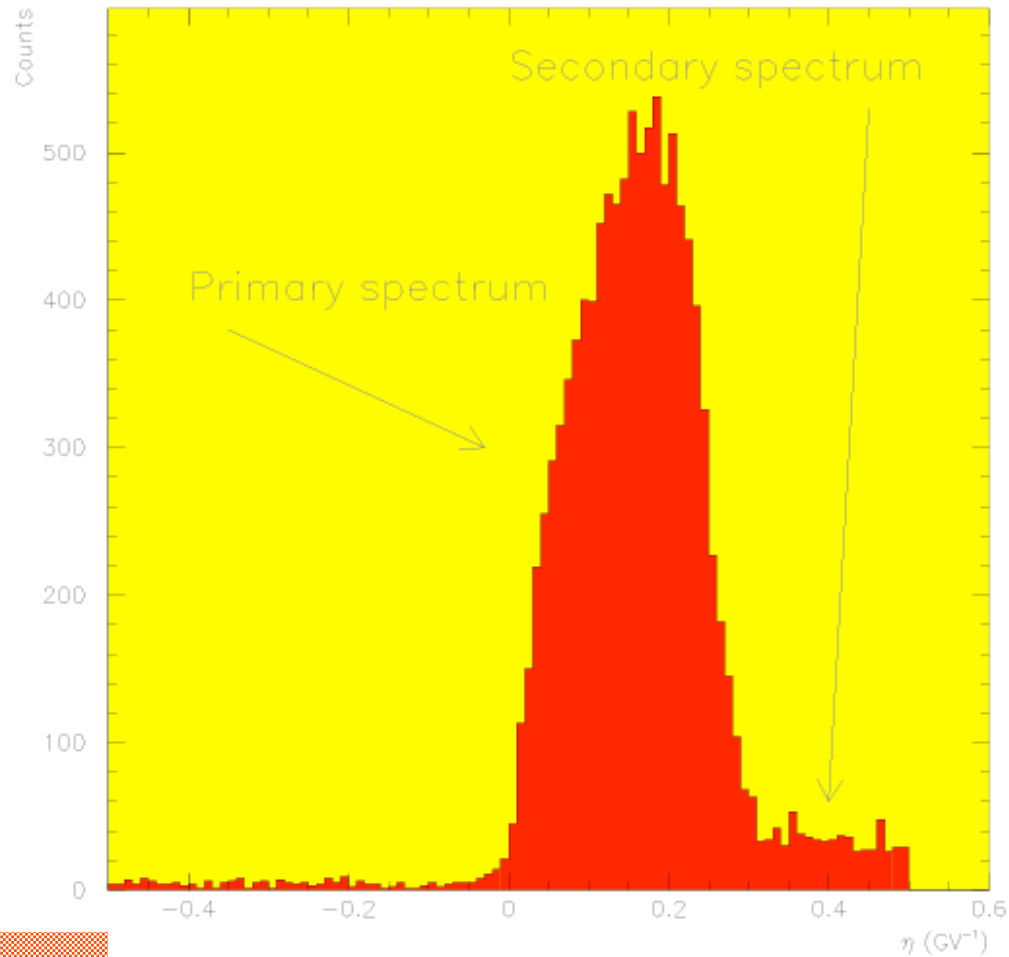

Spectrometer

In flight Performances

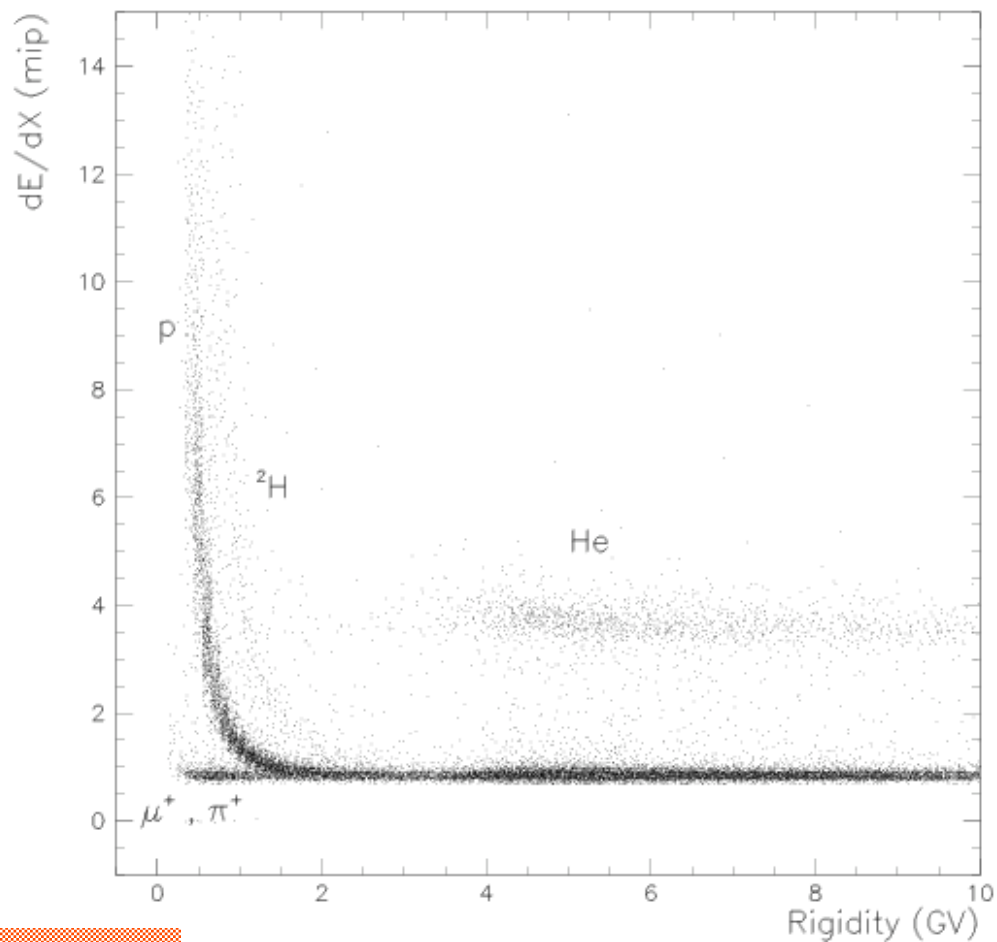

$$dE/dx \propto Z^2$$

vs p

Silicon calorimeter

In flight Performances

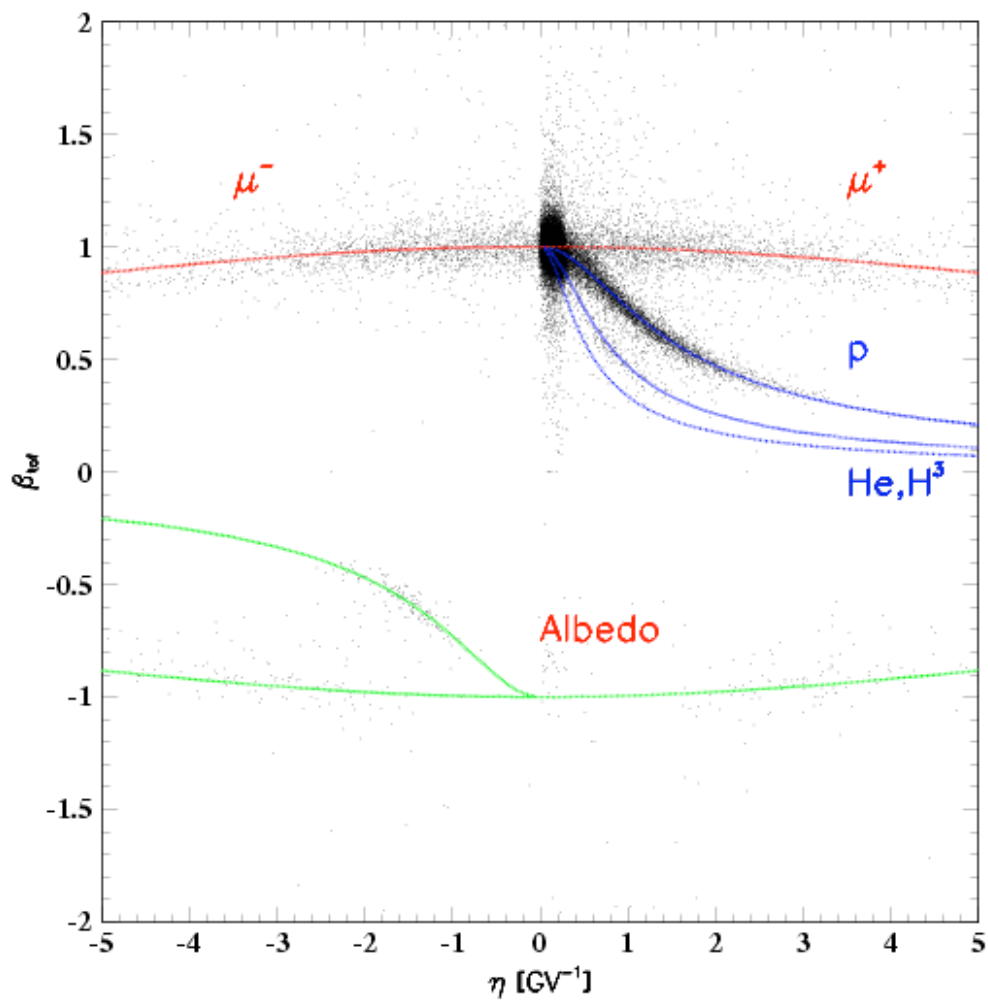

β vs $1/p \rightarrow$ mass

TOF

In flight Performances

β and $p \rightarrow$ mass

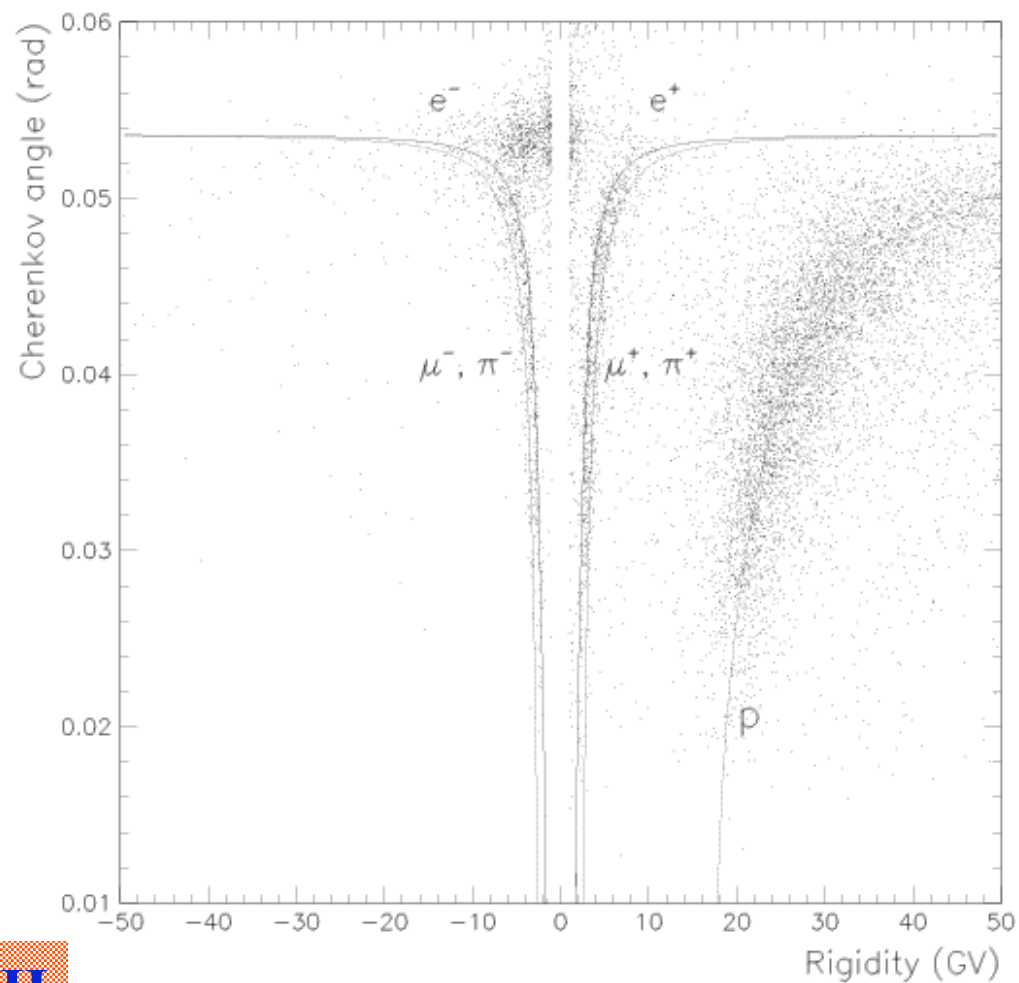

GAS-RICH

In flight Performances

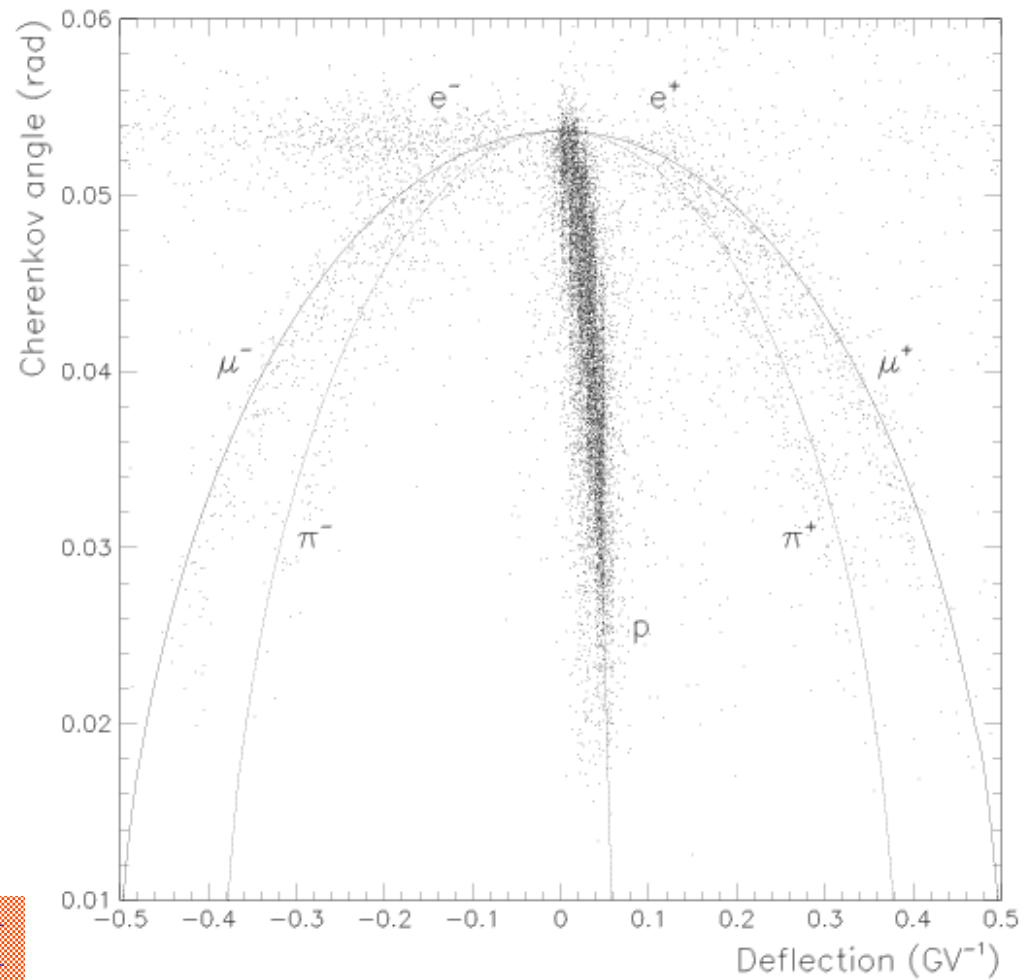

GAS-RICH

Exercise

Find a paper published by one of the described experiments or by another balloon experiment performing primary CR composition/anti-matter measurements and describe a measurement they perform and the detectors used for this purpose.